

JUSTIN 808

HD Radio™ Alignment Processor

Installation & User Guide



HD Radio Technology is manufactured under license from iBiquity Digital Corporation. U.S. and Foreign Patents apply. HD Radio™ and the HD and HD Radio logos are proprietary trademarks of iBiquity Digital Corporation.

PRODUCT REGISTRATION RECORD

JUSTIN 808 – Serial No. _____

Purchase Date _____

Warranty Registered? Web

Reg. Date _____ By: _____

Installation & Operation User Guide

JUSTIN 808

HD Radio™ Alignment Processor

July, 2015
Firmware Rev. 1.0.0.0

Inovonics, Inc. 5805 Highway 9
Felton, CA 95018
Tel: (831) 458-0552 Fax: (831) 458-0554
Register online at www.inovonicsbroadcast.com

TABLE OF CONTENTS

Section I – INTRODUCTION

JUSTIN 808 PRODUCT DESCRIPTION	5
Features	
JUSTIN 808 TECHNICAL SPECIFICATIONS	6
Off-Air Receiver	
Signal Path	
Networking	
Failover Audio Protection	
The User Interface	
Miscellaneous	
BLOCK DIAGRAM	7

Section II – INSTALLATION

GENERAL	8
Unpacking and Inspection	
Warranty Registration	
Mounting	
Heat Dissipation	
Radio Frequency Interference (RFI)	
AC MAINS CONSIDERATIONS	8
Mains Voltage Selector	
Mains Fuse	
Power Cord	
Brownout Detection	
CONNECTIONS	9
Antenna Input	
AES Program Audio Loop-Through	
Network Port	
GPIOs	

Section III – QUICK-START SETUP

CONSIDERATIONS	11
Preferred Installation in the HD1 Airchain	
Alternate Installation in the Analog FM Airchain	
Navigating the Menus	
De-Emphasis	
DETERMINE THE AIRCHAIN SIGNAL PATH.....	12
CONNECTION AND PRELIMINARY SETUP	12
VERIFY NETWORK CONNECTION AND OPERATION.....	13
SWITCH TO THE WEB INTERFACE	14

Section IV – ADVANCED OPERATING INSTRUCTIONS

JUSTIN 808 REMOTE ACCESS NOTES	15
Port Forwarding	
Dynamic DNS	
FRONT PANEL APPOINTMENTS.....	17
Graphic Display	
Headphone Jack	
“Split Mode” Audio Monitor	
Program Level Meters	
Delay Alignment Metering	
DELAY ERROR CORRECTION	19
Autocorrelation Defined	
Delay Plot	
Delay History	
Delay Correction Options	
The Delay Correction Rate	
Jump on Boot	
PROGRAM LEVEL CORRECTION	22
Measuring Loudness	
Enabling AGC	
AGC Rate	
Automatic Phase Correction	
Level Correction History	
DATA LOGGING.....	24
The Overview Screen	
Refreshing the Screen	
Detail View	
Statistics	
Events	
Saving the Log	
TIME SPENT	26
ALARMS AND NOTIFICATIONS	26
False Alarm Guards	
Enable Alarms!	
FM Audio Loss	
HD Audio Loss	
AES Audio Loss	
Flashing Alarms	
Audio-Loss Alarm Considerations	
Low Signal	
The Mute Function	
HD Carrier Loss	
Alignment Out of Range	

ALARM TALLIES.....	31
Polarity	
Type	
Status	
EMAIL AND SMS/TEXT NOTIFICATIONS.....	32
Setting-Up SMTP	
Texting to Mobile Devices	
Assigning Alarms	
ALARM LOG SETTINGS.....	34
GENERAL PURPOSE INPUTS & OUTPUTS	35
General Purpose Inputs (GPI)	
Polarity	
Type	
Status	
General Purpose Outputs (GPO)	
BALLGAME MODE	36
INSTANT JUMP	37
AES PASS-THROUGH	37
SNMP OPERATION	38
SNMP Overview	
SNMP Mode	
SNMP Security	
SNMP Ports	
SNMP Traps	
The MIB File	
ADMINISTRATIVE SETTINGS.....	39
Front Panel Password	
Web Interface Password	
Ballgame Mode Password	
Lost Password (Hard Reset)	
Hardware Profile	
Firmware Updates	
Headphone Volume	
About	
 Section V APPENDIX	
THE FRONT-PANEL MENU TREE	43
INOVONICS WARRANTY	(INSIDE BACK COVER)

Section I

INTRODUCTION

JUSTIN 808 PRODUCT DESCRIPTION

Inovonics' JUSTIN 808 is a time-alignment processor for exclusive use with the HD Radio® digital broadcasting system. The JUSTIN 808 brings analog FM and HD1 channels into perfect time and phase synchronism, and normalizes levels to match loudness between the analog and digital programs. This eliminates the pervasive HD Radio problem of echo, stuttering, lost or repeated words and level shift as hybrid-mode receivers cross-fade between analog and digital reception.

The JUSTIN 808 includes a full-function Web interface with SNMP support. This enables remote control with any PC, tablet, or smart phone Web browser. Signal loss and other alarms actuate rear-panel tallies, and the JUSTIN 808 can dispatch these as SMS/text or email messages. The unit logs all errors and can generate a graphical display of timing correction over an extended time period.

Features

Leading features of the Inovonics JUSTIN 808 include:

- Direct off-air reception, no dependence on other equipment
- AES3 digital audio pass-through with failover relay bypass
- A choice of signal-path connection options to accommodate HD or FM airchain installation
- Intuitive, menu-driven front-panel setup, plus a built-in Web server for full remote setup and operation over any IP network, LAN or Internet
- Supports SNMP remote monitoring and control
- Local, remote and self-logging alarms for out-of-limits events
- Email or SMS/text messaging options for alarm events.
- The JUSTIN 808 boots or resets *in less than five seconds* and begins autocorrelation and delay correction immediately.

JUSTIN 808 TECHNICAL SPECIFICATIONS

OFF-AIR RECEIVER

Antenna Input:

75-ohm ('F' connector)

Receiver Tuning Range:

87.5MHz-108.0MHz in 100kHz steps

Receiver Sensitivity:

The internal FM/HD Radio receiver requires approximately 20dB μ V (10 μ V) to recover analog and digital programs with adequate SNR for autocorrelation.

SIGNAL PATH

Digital Audio I/O:

The AES3 (XLR) 24-bit stereo audio pass-through operates at a fixed 44.1kHz sampling rate.

Available Audio Delay:

16 seconds

Available Audio Level Correction:

\pm 6dB

NETWORKING

An RJ45 jack accepts TCP/IP network connections for remote setup and operation of the JUSTIN 808.

FAILOVER AUDIO PROTECTION

Relay contacts bypass the AES digital audio pass-through in event of AC mains power loss.

THE USER INTERFACE

Front-Panel Interface:

A front-panel graphic display and jog wheel allow easy, menu-guided *in-situ* setup and operation of the JUSTIN 808.

Level Metering:

LED "VU" meters display FM, HD1 and AES loop-through program audio levels.

Delay Metering:

A segmented LED display shows FM-HD1 alignment, \leq 5 and \geq 5 samples.

Software Control:

The IP network port enables complete remote setup and operation of the JUSTIN 808 over a local network or the Internet using any desktop, tablet or mobile browser.

SNMP:

SNMP remote monitoring and control is supported.

MISCELLANEOUS

Headphone Jack:

A front-panel, quarter-inch (TRS) headphone jack allows the user to monitor either the AES digital audio passing through the JUSTIN 808, or the off-air signal in 'split mode,' with the analog FM signal in the left channel and the HD Radio signal in the right channel. Headphone volume is a menu item.

AC Mains Requirements:

90-130VAC or 200-255VAC, 50/60Hz; 7W

'Boot' Time:

\leq 3 seconds to full operation

Size:

W: 19in/483mm, H: 1 $\frac{3}{4}$ in/44mm,
D: 9 $\frac{1}{2}$ in/240mm (1U).

Weight:

9lb/4kg (net), 12lbs/5.4kg (shipping)

Environmental:

Continuous operation guaranteed at ambient temperatures between 32°F/0°C and 122°F/50°C; 0-95% relative humidity, non-condensing; altitudes to 10,000ft/ 3048m.

Conformances:



EN50081-1
EN50082-1
93/68/EEC



2002/95/EC

BLOCK DIAGRAM

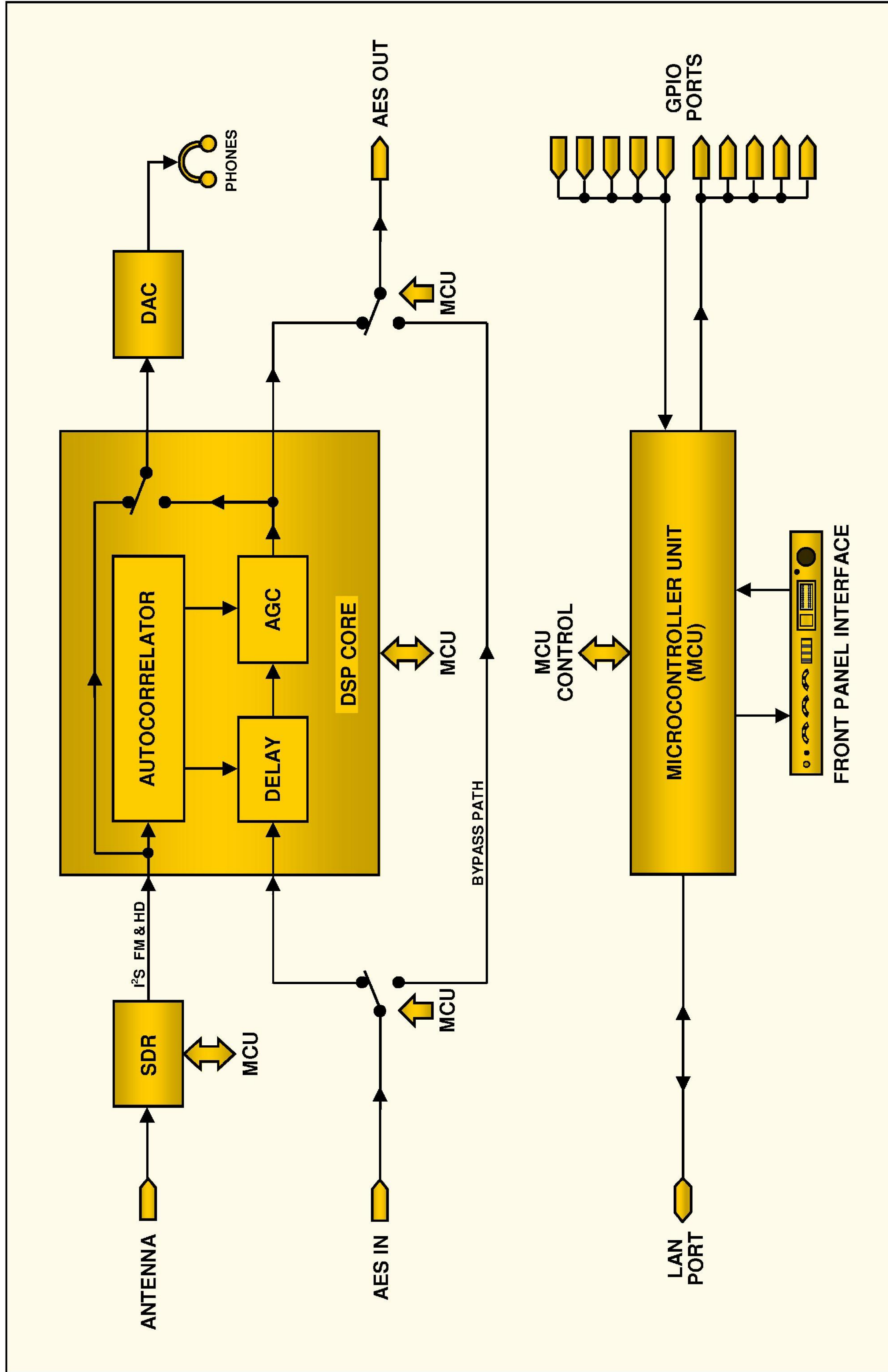

Block Diagram – JUSTIN 808 HD Radio™ Time Alignment Processor

Section II

INSTALLATION

GENERAL

Unpacking and Inspection

As soon as the equipment is received, inspect carefully for any shipping damage. If damage is found or suspected, notify the carrier at once, and then contact Inovonics.

We recommend retaining the original shipping carton and packing materials for return or transshipment. If returned for Warranty repair, shipping damage sustained as a result of improper packing for return may invalidate the Warranty!

Warranty Registration

IT IS IMPORTANT to register your JUSTIN 808 3-year Warranty. This assures coverage of the equipment under terms of the Warranty, provides a means of tracing lost or stolen gear, and adds the user to a database to receive specific service instructions or software/firmware updates when issued. Register online at: www.inovonicsbroadcast.com.

Mounting

The JUSTIN 808 mounts in a standard 19-inch equipment rack and requires only 1¾ inches (1U) of vertical rack space. We recommend using plastic or fiber washers to protect the painted finish around the mounting holes.

Heat Dissipation

With roughly the same energy consumption as a CFL porch light, the JUSTIN 808 itself generates negligible heat and thus has no noisy internal fan and associated filter to change. The unit is specified for operation within an ambient temperature range extending from freezing to 120°F/50°C. But because adjacent gear may radiate substantial heat, be sure that the equipment rack is adequately ventilated to keep internal temperature below the specified maximum ambient.

Radio Frequency Interference (RFI)

Although it is expected that the JUSTIN 808 will be co-located with FM transmission equipment, do practice care and common sense in locating the unit away from *abnormally* high RF fields.

AC MAINS CONSIDERATIONS

Mains Voltage Selector

Unless specifically ordered for export shipment, the JUSTIN 808 is set at the factory for operation from 115V, 50/60Hz AC mains.

To change the mains voltage, first *disconnect the mains cord* and then operate the slide switch adjacent to the AC mains

fuseholder on the rear panel. Use a small screwdriver to set the switch for 115V or 230V operation.

- Mains Fuse** It is important to install the appropriate fuse as noted on the rear panel next to the fuseholder: 1/4A for 115V mains, 1/8A for 230V operation. Fuses are the GMA/S500 type (5mm X 20mm size, 'fast blow').
- Power Cord** The detachable IEC-type power cord supplied with the JUSTIN 808 is fitted with a North-American-standard male plug. If you need to replace the mains plug with another, you will find that the individual cord conductors are color-coded in one of two ways. US standards specify black for AC 'hot,' white for AC neutral and green for earth ground. European CEE standards specify brown for AC 'hot,' blue for AC neutral and green with a yellow stripe for earth ground. Please keep these straight.
- Brownout Detection** Although the JUSTIN 808 power supply and digital logic circuits will operate at AC mains voltages below nominal, the graphic display and LED readouts would fail to give consistent indications at very low mains voltages. A 'brownout' detector reboots the unit at a mains voltage somewhat below the "low line" value given in the product specification.

CONNECTIONS

- Antenna Input** The antenna input for the internal off-air receiver is a 75-ohm 'F' connector. To operate at the peak of its autocorrelation performance, the JUSTIN 808 requires a solid incoming RF signal devoid of multipath artifacts. Installed at a studio location, a rooftop antenna aimed at the transmitter is recommended. But when the unit is co-located with the transmitter, a short length of wire dangling from the antenna connector may well suffice. The FM and HD signal bars on the Tuner menu should both be within a bar or two of the top.

- AES Program Audio Loop-Through** The JUSTIN 808 may be connected either in the HD1 program audio signal path or in the FM program audio signal path. This is an AES3 digital audio connection with the standardized HD Radio digital audio sampling rate of 44.1kHz.

For reasons stated in the Quick-Start Setup section, the preferred connection for the JUSTIN 808 is in the HD1 digital audio feed to the HD exciter or exporter. Interconnection for this mode is diagrammed on Page 12. The audio gain for the AES digital audio loop-through can change as much as ± 6 dB if AGC is enabled for FM/HD1 level-matching.

The alternate connection, with the JUSTIN 808 in the digital audio feed to the FM audio processor, is also diagrammed on Page 12. In this mode the JUSTIN 808 maintains unity gain for the AES digital audio loop-through.

Network Port The rear-panel RJ-45 NETWORK PORT connects the JUSTIN 808 to a Local Area Network (LAN) or to the Internet. The internal Webpage interface affords full remote control, timekeeping, alarm notifications and logging, and SMTP support.

Basic network connection was covered in the Quick-Start Setup section. Additional notes appear elsewhere in the manual.

GPIOs The rear-panel screw-terminal connector carries five software-assignable general purpose inputs and five assignable outputs. Ground and a current-limited +5VDC supply are included for your convenience, and this terminal strip unplugs from the chassis to make connection easier.

General-purpose inputs (GPIs) are assigned by navigating to **Setup / General Purpose Inputs**, using either the front-panel knob or the Web interface. On this menu, **Input 1** through **Input 5** may be individually selected, and logic **Polarity** specified for that particular input. These inputs have internal pull-up resistors to the +5V supply. An **Active Low** selection would normally be looking at an open circuit and activated by applying a ground. An **Active High** selection means that the input would normally be grounded and activated when the ground was removed.

The **GPI Type** field allows assignment of the specified input to engage either the **Ballgame Mode** (see Page 34) or **AES Pass-Through**, which bypasses the JUSTIN 808 out of the signal path (see Page 37).

General-purpose outputs are similarly assigned by navigating to **Setup / General Purpose Outputs** with the front-panel knob or using the Web interface. Here again, **Output 1** through **Output 5** can be assigned a **Polarity**, **Active Low** pulling the specified terminal to ground (NPN transistor saturation) for an alarm condition and **Active High** normally a ground going open on an alarm.

GPO Type assigns the selected output to a specific alarm condition. There are six alarms, and these are discussed beginning on Page 26. The GPO closures (or opens) are referred-to as “tallies” in the alarm discussions.

Section III

QUICK-START SETUP

This manual contains detailed and complete information regarding installation and operation of the JUSTIN 808. In the interest of getting the unit on-air quickly, however, following the simple steps given in this Quick-Start Setup section will get the tech-savvy user up and running in the shortest possible time. We do, nevertheless, strongly recommend consulting the full text of the manual for explanation and guidance through any setup irregularities, and to introduce the many operational features that are available but not included in this Quick-Start section.

CONSIDERATIONS

- | | |
|---|---|
| Preferred Installation in the HD1 Airchain | Two basic installation modes are available to you. The <i>preferred mode</i> places the JUSTIN 808 in the HD1 airchain. In this mode, slightly more ‘diversity delay’ is purposely programmed into the FM audio path, and the JUSTIN 808 then provides variable delay of the HD1 program audio to maintain time alignment. The advantage of this mode is that the JUSTIN 808 can also do whatever small amount of audio level correction may be necessary to give FM and HD the same apparent loudness when the receiver fades between reception modes. |
| Alternate Installation in the Analog FM Airchain | The <i>alternative installation</i> places the JUSTIN 808 in the FM airchain, where it can provide all or part of the 8+ seconds of diversity delay, adjusting overall delay as required to keep FM in sync with HD. The disadvantage here is that level correction is not possible. |
| Navigating the Menus | <i>Turn</i> the front-panel knob to navigate through the JUSTIN 808 menus. <i>Push</i> the knob to enter a setup menu, <i>push</i> again to get into any required sub-menu, and then <i>turn</i> the knob to make a selection. Finally <i>push</i> once more to commit that selection to memory. Use the BACK button to return to a previous menu and, ultimately, to the Main Menu. |
| De-Emphasis | Analog FM program de-emphasis is determined by broadcast operating regions. North America utilizes a 75-microsecond characteristic; Europe and much of the rest of the world has standardized on 50 microseconds.

JUSTIN 808 de-emphasis is set under Setup / De-Emphasis. Check that the setting is appropriate for your area: Ⓒ 50us or Ⓒ 75us. |

NOTE: THE FOLLOWING STEPS SHOULD BE PERFORMED ONLY IN THE SEQUENCE PRESENTED. **DO NOT CONNECT THE JUSTIN 808 TO THE INTERNET UNTIL STEP 6.**

DETERMINE THE AIRCHAIN SIGNAL PATH

1. Based on the information given above, decide whether the JUSTIN 808 will serve you best in the 'preferred' HD1 airchain program signal path, per the following diagram:

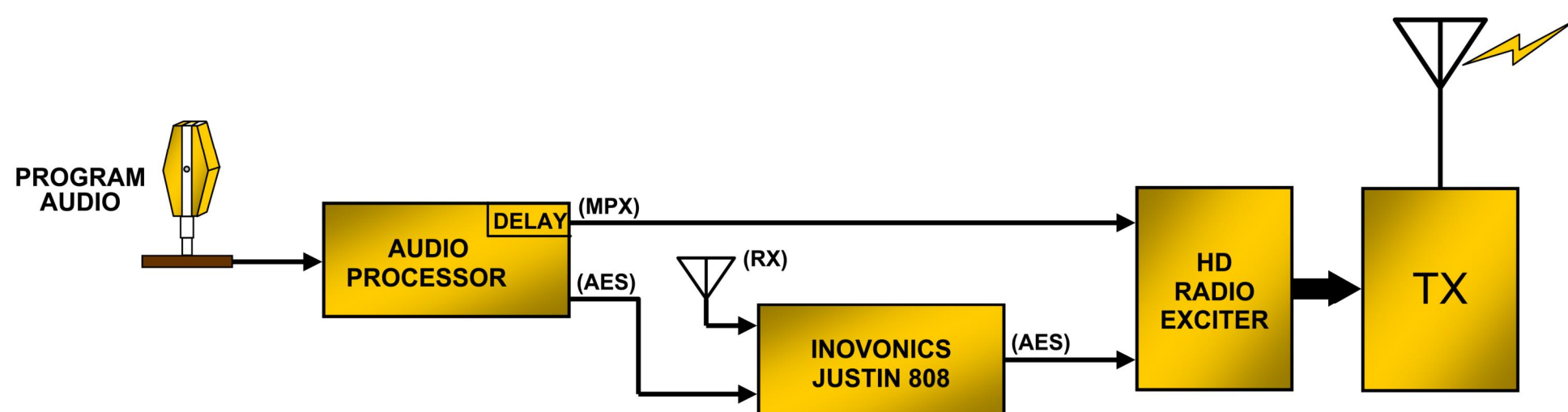

JUSTIN Implementation in HD Radio Air Chain With Single Audio Processor

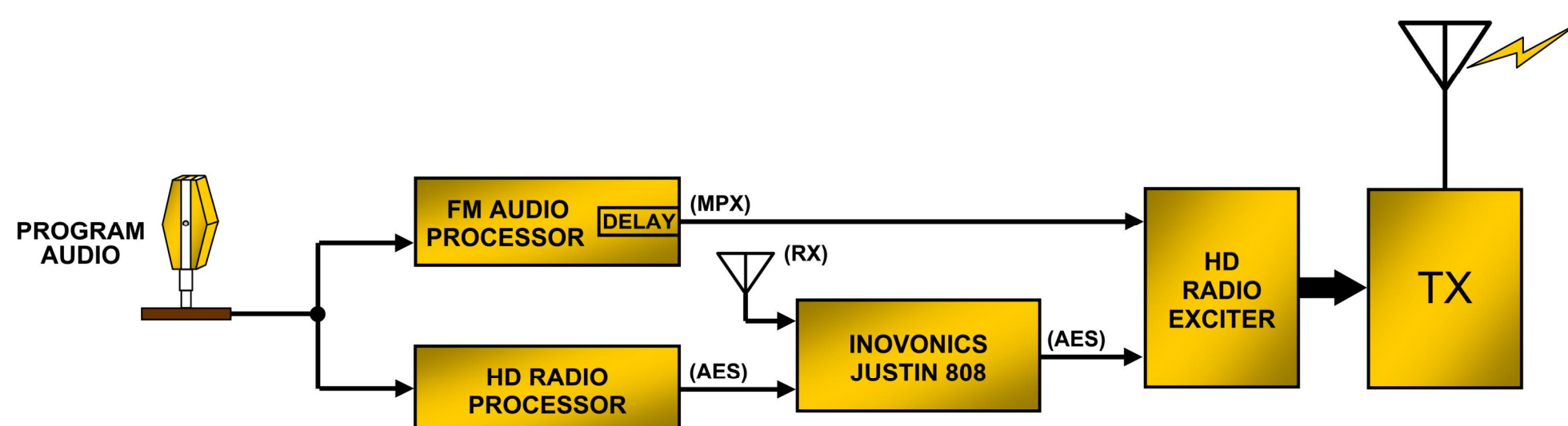

JUSTIN Implementation in HD Radio Air Chain With Dual Audio Processors

...or in the analog FM airchain program signal path as shown below:

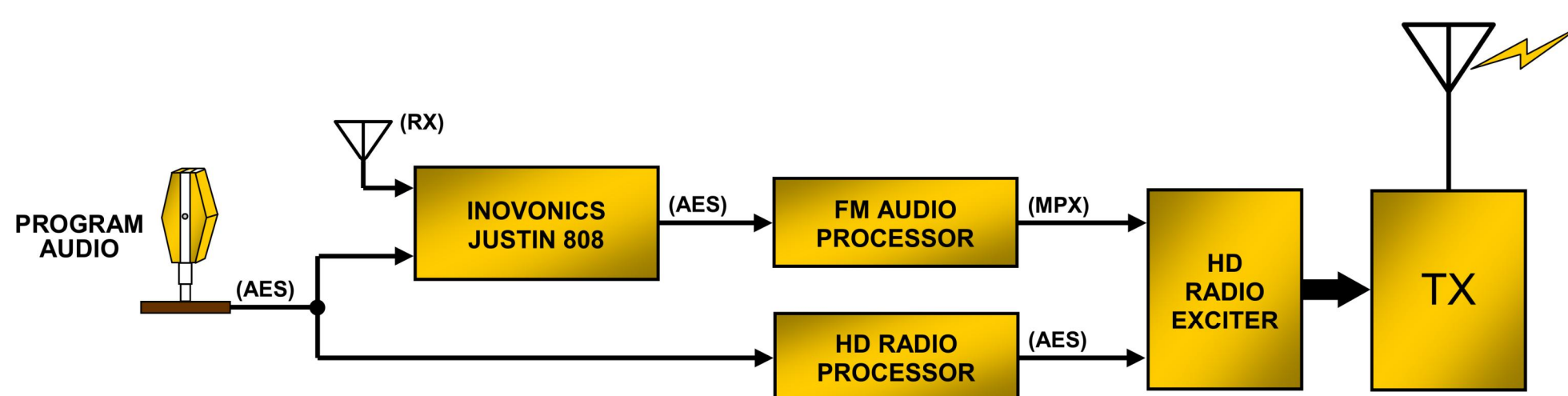

JUSTIN Implementation in FM Air Chain With Dual Audio Processors

CONNECTION AND PRELIMINARY SETUP

2. Connect your receive antenna and loop AES audio through the JUSTIN 808 as determined in Step 1. Apply AC mains power, but **DO NOT MAKE A NETWORK CONNECTION AT THIS TIME!**

3. Assign the JUSTIN 808 to the same signal path as your loop-through connection. Navigate to **AES Audio Adjustments / AES Airchain** and select either the **⦿ Digital HD1** airchain path or the **⦿ Analog FM** airchain path.
4. Tune the JUSTIN 808 to your station. Navigate to **Tuner** and the default frequency **[98.10]** will be bracketed. Push and turn the jog knob to dial-in your station's carrier frequency. Signal level bars on the right side of this screen will indicate incoming signal quality, and both should be within a bar or two of the top.
The JUSTIN 808 requires a strong incoming signal to do the best job of correcting timing and level errors. This generally means an outdoor antenna pointed toward the transmitter site when the unit is located at the studio. If co-located with the transmitter, a dangling piece of wire may well suffice.
5. Set up the time offset and DST. Navigate to **Setup / Network / Time / Time Zone & DST**. Checking the **Auto DST** box will set Daylight Saving Time for you automatically. Set the **Time Zone** slider to the proper offset as required for your area (e.g., UTC-8.0 for the US west coast, UTC-5.0 for the east coast).
The correct date and local time will NOT be displayed at the bottom of the OLED screen at this point. The JUSTIN 808 depends on an Internet time provider for the proper logging and messaging of alarm events.
6. Now plug in the network cable and set up the networking parameters. Navigate to **Setup / Network / IP Settings**. Set the selection to **DHCP** for automatic IP address assignment by your router, or to **Static IP** if that's the mode you elect to use. If you choose **Static IP**, then you must manually enter values for: **IP:**, **Gateway:**, **Subnet:** and **DNS:**.

VERIFY NETWORK CONNECTION AND OPERATION

Once networking has been set up, go back to **Setup / Network / Time / Time Zone & DST** and verify the correct date and time at the bottom of the OLED screen.

At this point the JUSTIN 808 should be into its autocorrelation routine. Soon the front-panel **ALIGNMENT** indicator will stop its side-to-side 'searching' motion.

7. Navigate to **FM/HD Measurements / FM/HD Radio Time**. When the JUSTIN 808 calculates the timing misalignment, this will be indicated under **Measured Delay**, both in the number of **Samples** and in milliseconds of **Time**. **Status** will show whether the HD is leading or lagging the FM.

The **Applied Delay** numbers will slowly increase as the **Measured Delay** numbers decrease. You may accelerate this process by navigating to **Setup / Instant Jump** and actuating the **Go!** button.

This will instantly jump the applied delay to the correlated delay time, obviating a long wait, but this will be audible on-air.

SWITCH TO THE WEB INTERFACE

You are now at liberty to switch over to the JUSTIN 808 Web interface using a computer, tablet or mobile device that is *on the same network*.

Navigate to **Setup / Network / IP Settings** and enter the IP: address shown there into your browser address bar. Remaining setup of the JUSTIN 808 will be easier using the Web interface, although the front-panel OLED display, knob and **BACK** button may still be used for any setup option.

This completes Quick-Start setup. Refer to the appropriate pages in this manual for setting up alarms, email and SMS/text notifications, plus other important features and options that have not been covered here.

Section IV

ADVANCED OPERATING INSTRUCTIONS

The Quick-Start Setup section of this manual gave an abbreviated procedure for placing the JUSTIN 808 into service as quickly and simply as possible. Quick-Start neglects the finer points of setup and operation, but this section will explain the JUSTIN 808 in greater depth and introduce the numerous additional features that are available, such as graphic displays, alarms and error logging.

From this point forward, operation of the JUSTIN 808 will, in large part, assume the use of the built-in Webpage server. Anything (and more!) that can be done from the front panel can also be accomplished using the Web interface, and bringing-up the Web interface is as easy as entering the JUSTIN 808 IP address into a computer, tablet or smart phone browser. The Web interface and front-panel data entry share a common theme for controls and readouts, and the use of either is really quite intuitive.

The Appendix (Page 42) gives a tabulated listing of all front-panel OLED menu items. The front-panel menus parallel the Web interface menus that will be referenced here, so this menu listing is a good reference for basic understanding of the unit.

JUSTIN 808 REMOTE ACCESS NOTES

To access the JUSTIN 808 on a common local network (LAN), just enter its IP address into your browser's address bar.

But to address the JUSTIN 808 from *outside* your LAN (from the Internet), the unit must have a static IP address. If your router makes DHCP assignments for other equipment on the network, simply assign the receiver a static IP that is outside the router's DHCP group range. This should be an easy matter with the aid of the router's Help utility. A static IP address for the JUSTIN 808 is entered on the Network submenu. Switch Mode: from DHCP to Static IP and type-in the requisite information.

Port Forwarding

It will be necessary to specify a port for the JUSTIN 808 on the network router. Within the router's Port Forwarding utility you are able to enter your static IP address for the unit (Internal IP), followed by a colon and a port number. The port number may be any number in the router's range.

If your Internet Service Provider (ISP) assigns you a static IP address, then it is a simple matter to address the JUSTIN 808

from anywhere. Just type the IP address and port number into your browser as shown at the right.

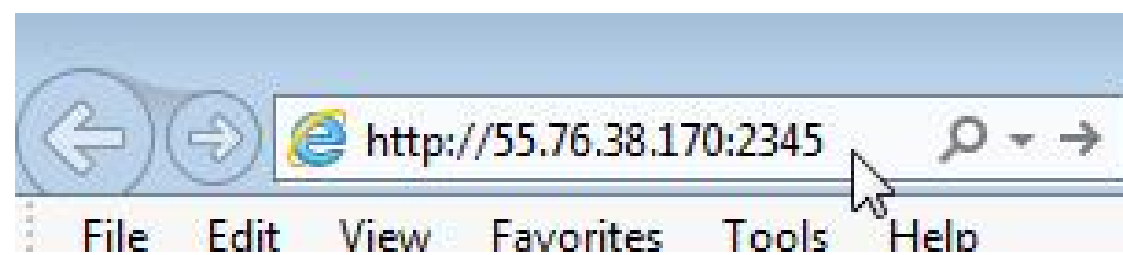

But if your ISP issues you a *dynamic* IP, which is very often the case, this mandates the use of 'Dynamic DNS,' using the services of an IP-forwarding provider.

Dynamic DNS

It would not be possible to address equipment behind a dynamic IP address if it were not for IP-forwarding providers available on the Internet. Their services, which are either free or at a very modest charge, will allow the JUSTIN 808 to keep the provider apprised of its reassigned IP address each time that address is updated by the ISP. The IP-forwarding provider intercepts data attempting to connect with the JUSTIN 808 and converts a stale IP address to the updated one.

There are three popular forwarding service providers available on the Internet. Their basic service (all you really need) is normally free of charge, but advanced features might command a nominal annual fee. All services require registration on the appropriate Website.

Under the Dynamic DNS menu, the factory-default selection in the Mode: field is Disabled. Click this field for a drop-down list to choose among the three popular providers. Write down the provider names and enter each in your Web browser to learn more about their services, and to register with whichever provider seems best to meet your needs.

When you register, the provider will guide you through the selection of a Hostname:, a Username: and a Password:. Type these into the three fields. Next, click Save. The JUSTIN 808 will communicate with your dynamic DNS provider and confirm that the data you have entered are correct. When finished, the screen should approximate the example shown here.

A screenshot of a web form for Dynamic DNS configuration. At the top, a yellow banner displays the message "The last update was successful." Below this, the form contains several fields: "Mode:" with a dropdown menu showing "noip.com"; "Hostname:" with the text "justin_at_kino.no-ip.org"; "Username:" with the text "CE@kino.com"; and "Password:" with a masked field of dots. At the bottom of the form is a large yellow button labeled "Save".

FRONT PANEL APPOINTMENTS

All setup and operating adjustments of the JUSTIN 808 are under firmware control. There are no jumpers, switches or mechanical potentiometers, only the front-panel ‘jog’ knob, A; the Back button, B; and the OLED display, C identified in the illustration below.



Again, you *turn* the knob to cycle among highlighted menu items, and then *push* the knob to enter, select or adjust the highlighted item. The Back button returns you to the previous menu; push the Back button repeatedly to return to the Main menu.

Graphic Display

The OLED graphic display screen, C, presents the setup menu tree in an easy-to-read format. The display does have a screen saver mode, which either dims the display or turns it off after a specified period. If the screen goes dark, simply push the knob or Back button once to bring the screen to life. No selection or change is made with this ‘wake-up call.’

Only the front-panel knob gives access to the display settings. Navigate to **Admin / Display** to set screen **Brightness**, and to set the timeout mode. Check the box to **Dim** the display after the timeout interval or uncheck it (**Dim**) so that the display turns completely off. The **Timeout** period maybe set in 5-minute increments between five and sixty minutes.

Headphone Jack

The front-panel headphone jack accepts any quarter-inch TRS (stereo) plug, and can drive headphones of any impedance.

When a plug is inserted into this jack, the front-panel OLED display will go immediately to the Headphone Volume screen. Push the knob and adjust the level for comfortable listening.

The MONITOR SELECT switch to the right of the jack cycles the headphones between L-FM / R-HD1 and AES. The first option routes monaural analog FM audio to your left ear, and monaural HD1 audio to your right. This is the “split mode” of HD Radio reception, and enables an audible confirmation of time alignment.

The AES monitor option routes the delayed (processed) stereo AES digital audio signal to the headphones. This can, of course, be as much as 8+ seconds ahead of the off-air broadcast.

“Split Mode” Audio Monitor

When the analog FM and digital HD1 programs are in sync; that is, when they are perfectly time-aligned, you will hear monaural program audio ‘in the center of your head.’ This is to say that

there will be no perceived echo, and little if any “pseudo stereo image” in what you are listening to.

If the audio processing between the FM and the HD1 program channels is vastly different, there may be instances when you’ll swear you’re hearing stereo, but the effect will be without any real directionality, and will be level- and frequency-dependent. Audio monitoring does not have the sophistication and power of the auto-correlation function of the JUSTIN 808, and should never be considered an ‘ultimate authority’ when it comes to time alignment.

Program Level Meters

Three linear-dB level meters render a peak-weighted display of: FM, the off-air L+R monaural FM program signal; HD1, the off-air L+R monaural HD1 program signal; and AES, an L+R monaural version of the processed AES3 digital audio program leaving the JUSTIN 808.

When the broadcast is time-aligned, the FM and the HD1 displays should look nearly identical, perhaps separated in ballistic response by any differences in audio processing between the two programs. The AES meter, on the other hand, will lead the other two by the 8+ seconds of delay that is characteristic of the HD Radio encoding and decoding process. Each of these meters has an accompanying AUDIO LOSS indicator, which indicates loss only if the alarm for that function has been enabled, however. (See ALARMS AND NOTIFICATIONS on Page 26.)

These three level readouts also appear with better resolution on the Now Playing page of the Web interface, as shown here.

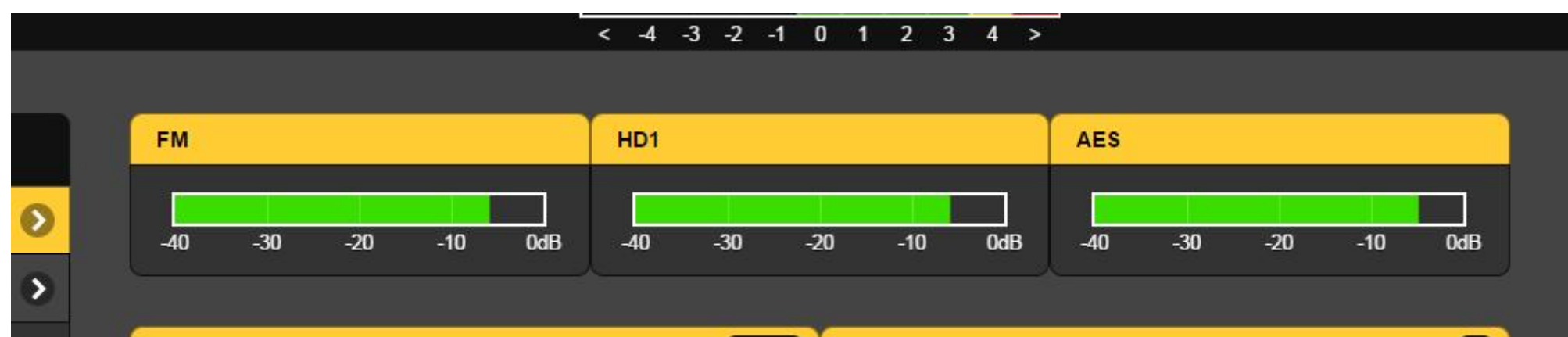

Delay Alignment Metering

The front-panel FM-HD1 ALIGNMENT indicator actually performs multiple display functions. If the JUSTIN 808 has not yet achieved correlation between the FM and HD1 programs, a single LED ‘hunts’ back and forth across the face of this display.

The FM-HD1 ALIGNMENT indicator has a display range restricted to ± 5 samples, corresponding to just ± 113 microseconds of alignment error. The JUSTIN 808 is capable of auto-correlating and maintaining alignment to within ± 1 sample, so when the front-panel indicator ‘pegs,’ as shown here, this indeed represents a time misalignment that the JUSTIN 808 will strive to correct.

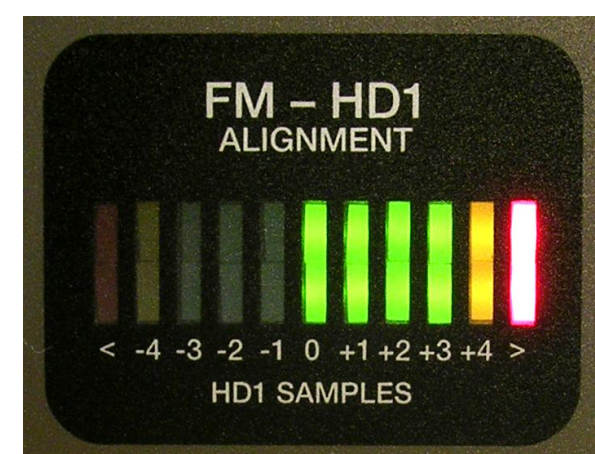

Once the JUSTIN 808 has achieved autocorrelation, but before full delay correction is applied, the ‘pegged’ front-panel indicator will appear to ‘strobe’ while the applied time delay is hom-

ing-in on a final correction. Once the timing error is corrected, the indicator should remain within a sample or two of zero at all times.

An FM-HD1 Alignment meter also heads the top of each Web interface page, duplicating the action of the front-panel meter, save for ‘strobing’ effect while delay is being corrected.

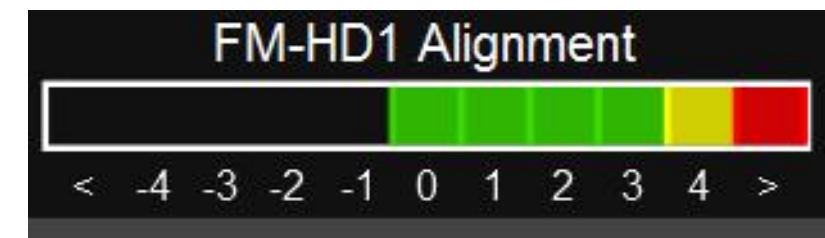

DELAY ERROR CORRECTION

Autocorrelation Defined

The term ‘autocorrelation’ refers to a very complex process that is the heart of the JUSTIN 808. There is no timing signal broadcast as part of the ‘hybrid’ HD Radio FM/HD1 broadcast. The HD Radio encoding/decoding process takes in excess of 8 seconds, requiring the FM broadcast channel to be ‘diversity-delayed’ by this same time period.

Diversity delay may be set with some degree of accuracy by listening to both the FM and the HD1 programs in the ‘split mode’ offered by many HD Radio receivers, including the JUSTIN 808. The human ear/brain interface is sensitive to a time and a phase difference between audio sources, and the proper delay was historically dialed-in by this method.

To perform this task automatically, the JUSTIN 808 must actually listen to the program audio and perform a cross-correlation in much the same manner as a human operator. This requires a very sophisticated mathematical process implemented with digital signal processing (DSP) algorithms.

The time required for autocorrelation is dictated in large part by the 8+ seconds of delay inherent in the HD Radio system, and further aggravated by the degree of time misalignment between the FM and HD1 programs. A second factor is the composition of the actual program material, which takes account of the spectral and amplitude distribution of the signal waveforms and even the ‘rhythm’ of the audio.

Once autocorrelation has been achieved, the JUSTIN 808 will immediately begin to correct for FM/HD1 timing errors.

Delay Plot

Delay alignment is shown with best clarity through the Web interface. On the Now Playing screen, both the measured and the applied delays are shown graphically as one-minute history plots, as well as numerical values of the current number of program audio samples at 44.1kHz.

The following example shows the JUSTIN 808 correcting a timing error that was purposely introduced to illustrate this action. The diversity delay in the FM airchain was increased by 500 samples, which was quickly correlated and displayed on the auto-ranging Measured Delay screen. The Applied Delay readout

shows the JUSTIN 808 slowly correcting the error at the default rate of 50 samples per second. Implications of faster correction rates were mentioned in the Quick-Start Setup section, and are discussed in greater detail later.

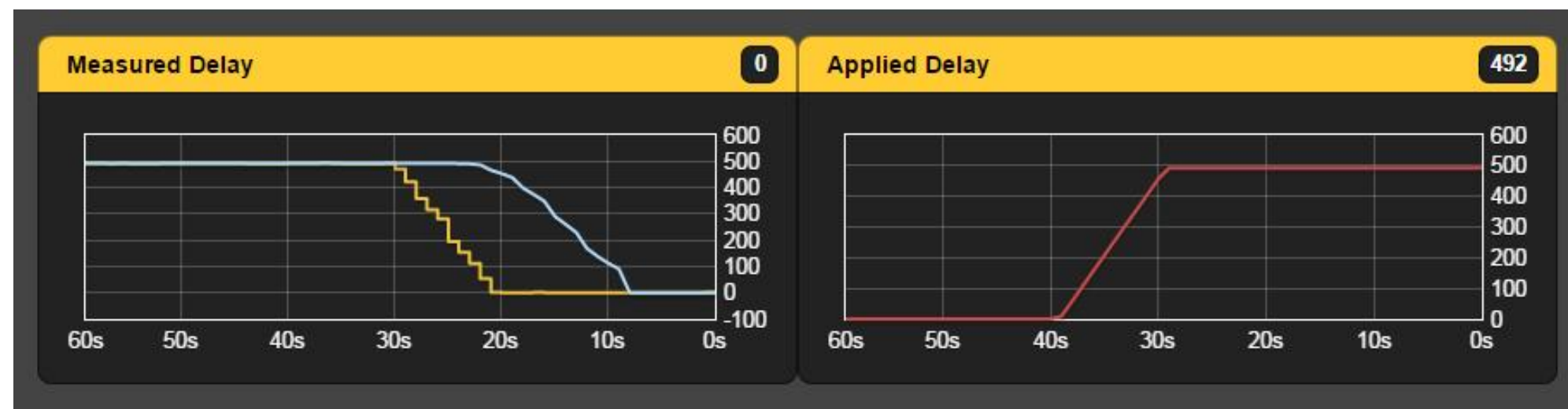

Additional options and information are available on the FM/HD Measurements menu shown below.

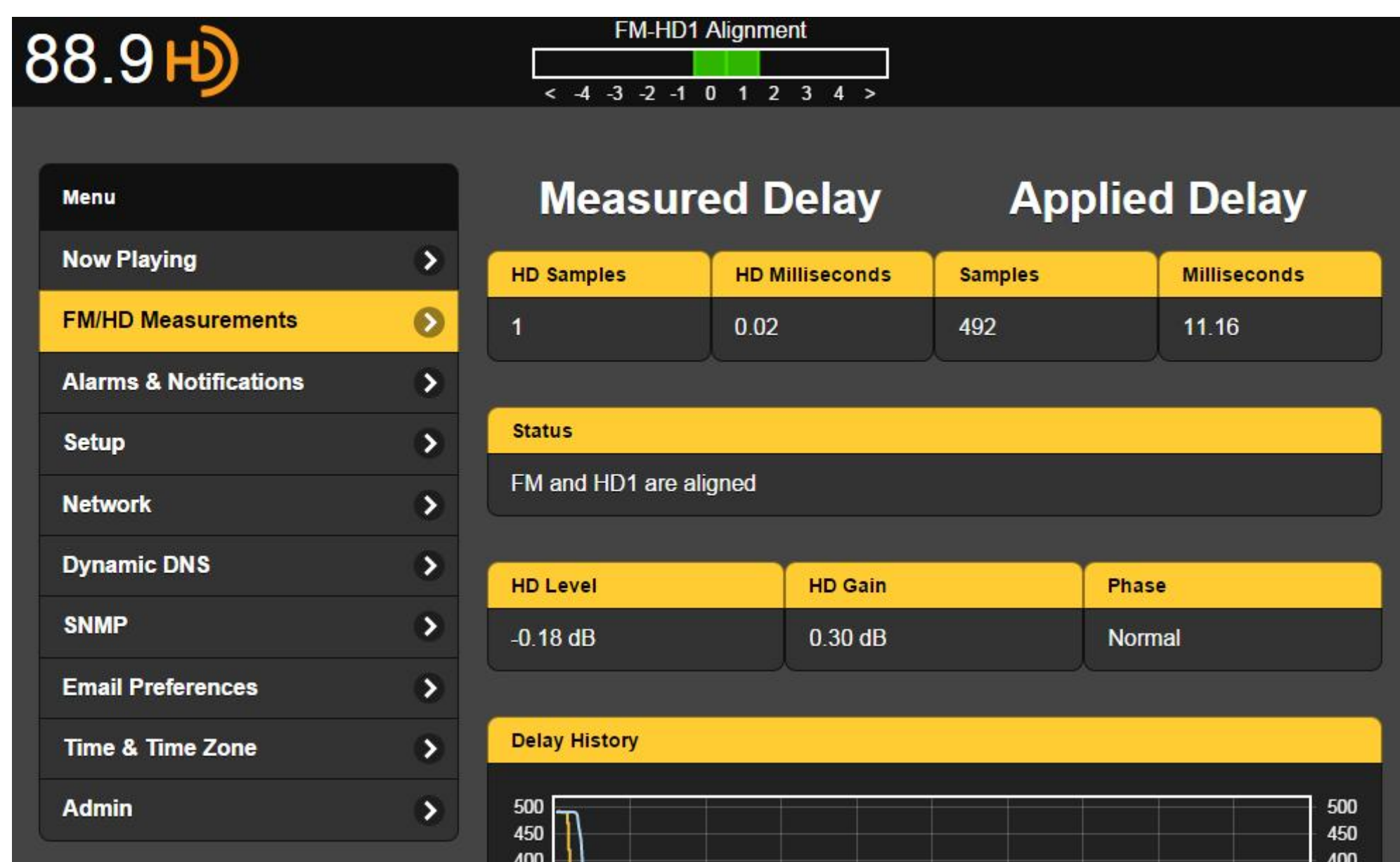

The measured and applied delays are shown both in the number of samples and in milliseconds. The Status box confirms any offset and makes note of whether the HD1 leads or lags the analog FM.

Delay History

Scrolling down this menu reveals the Delay History plot. This screen shows 10 minutes of history, both the measured and applied delays. The upper plot showing measured delay is further broken down into the yellow Inst. (instantaneous) measurement and the integrated blue Ave. (averaged) value. Inst. represents fluctuations in the measure delay as quickly as the autocorrelation algorithm can calculate them, which with moderate and typical wanderings is pretty darned snappy. The time-averaged Ave. value is the basis for the applied delay, which will eventually bring the measured delay back to zero.

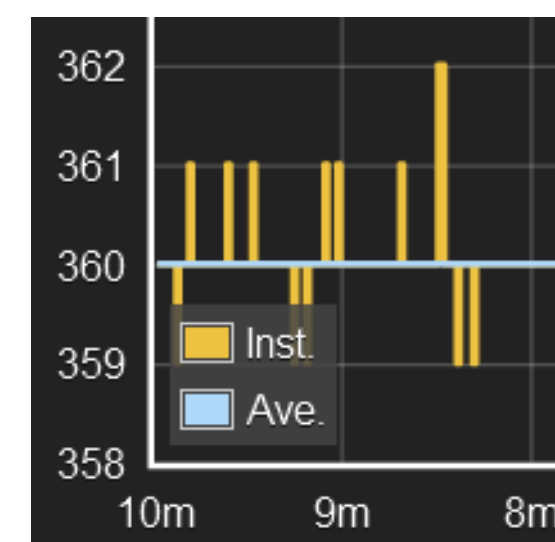

The JUSTIN 808 maintains a long-term delay history for an indefinite period so that trends may be analyzed over days, weeks and months. See the Data Logging discussion on Page 24.

Delay Correction Options

Under Setup and AES Audio Adjustments you will find a host of switches and sliders. The top switch, Enable Delay:, simply turns On or Off the JUSTIN 808 primary function of time-aligning the analog FM and digital HD1 programs. At the bottom of this screen are the Airchain: ‘radio buttons’ to assign the JUSTIN 808 to the proper signal path, as instructed on Page 13, Step 3. Other controls are covered in appropriate discussions.

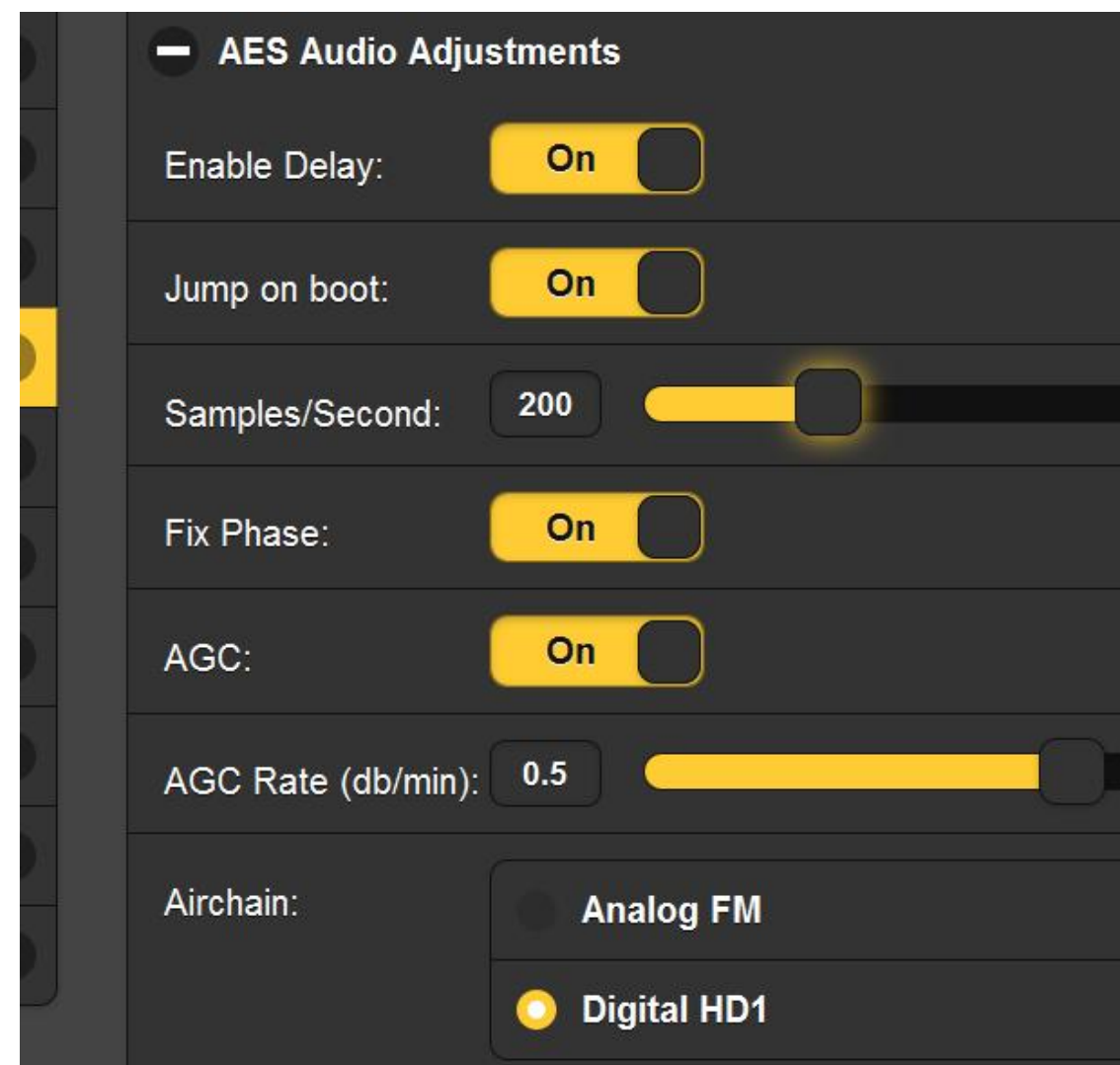

The Delay Correction Rate

As discussed in the Quick-Start Setup section, the factory-default delay correction rate is a leisurely 50 samples per second. This means that a one-second time offset would take the JUSTIN 808 a full *fourteen minutes(!)* to correct.

Again, this molasses-like default value is in deference to Nielsen’s Portable People Meter (PPM), a widely-used system for auditing a listening audience to determine market share. The PPM depends on a subliminal family of audio tones buried in, and masked by, program content. Any change in the frequency of these tones renders the system useless.

The JUSTIN 808 corrects for FM-to-HD1 misalignment by slowly moving the audio in time. This creates a frequency shift, much as a moving train whistle demonstrates a Doppler shift. Musically-trained individuals are said to be able to resolve a pitch shift of 2Hz. At 440Hz (musical ‘A’), a delay correction rate of 200 samples per second (sps) might be audible to a select few listeners. But the Nielsen PPM is even more sensitive than this and requires a correction rate something under 100sps.

The factory-default value of 50sps can be considered unconditionally safe, but will take a good long while to correct significant errors. In actual operation, once the FM and HD1 timing error has been brought to zero, whatever mechanisms are responsible for causing the timing to wander are typically very-long-term, and a correction rate of 50sps should keep the error within the ± 3 sample limit suggested by iBiquity Digital Corp.

The factory-default correction rate may be reset by the user. The Samples/Second: slider may be set to any figure between 10sps and 1000sps. If the Nielsen PPM is not an issue, you can safely set this to 200sps. Either drag the slider, or highlight the current number and enter your preference.

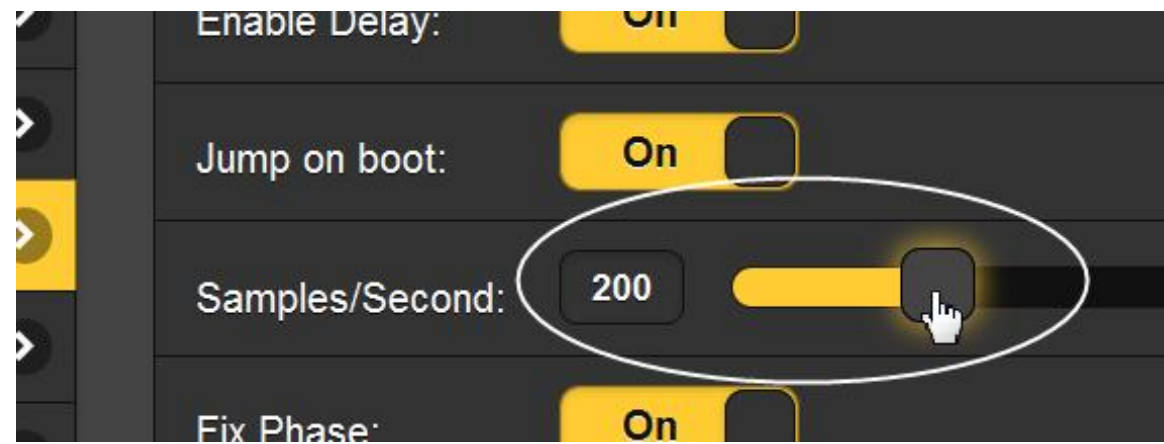

Jump on Boot

The JUSTIN 808 has a feature that negates a long wait to achieve error correction after an AC mains power interruption.

A switch marked Jump on boot may be found under the AES Audio Adjustments sub-menu. The factory default for this switch is On. This means that as soon as the JUSTIN 808 acquires correlation,

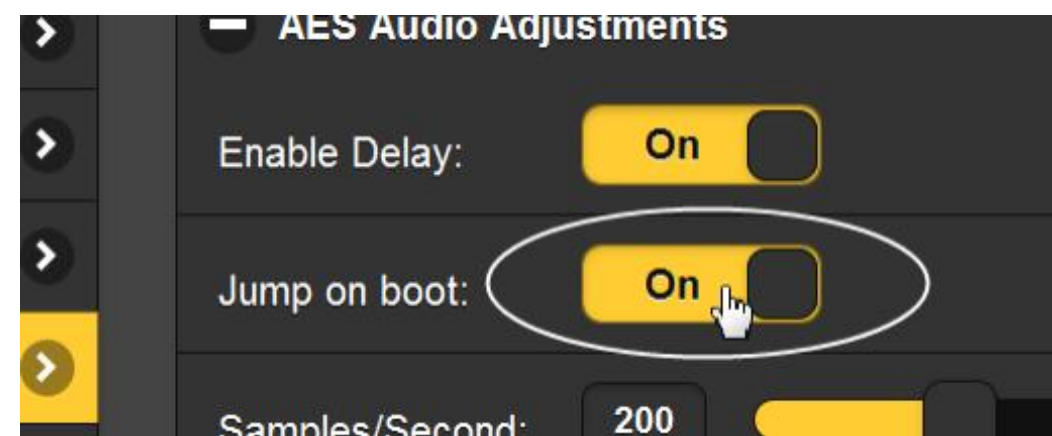

it will correct the delay error and bring the analog FM and digital HD1 programs into time alignment instantly. There really is no valid reason for turning this switch Off, unless the slow alignment recovery following a power glitch is somehow considered a plus.

PROGRAM LEVEL CORRECTION

The JUSTIN 808 can automatically correct for up to ± 6 dB loudness difference between the FM and HD1 programs, but only when it is connected in-line with the processed AES digital audio feeding HD1 programming into the exciter or exporter. It would not be possible to control the level of the FM airchain signal, as the FM audio processor would negate any level change in the signal feeding it, and changing the level after FM program processing would directly affect FM carrier deviation.

Measuring Loudness

The JUSTIN 808 measures and responds to true-r.m.s. levels of the off-air FM and HD1 broadcasts, and incorporates relevant provisions of the recommended ITU BS.1770-3 loudness measurement specification.

It is important to note, however, that many broadcasters employ separate, and often quite different, audio processing methods for their FM and HD1 simulcasts. Thus the two programs can sound a bit different to a listener in an ideal listening environment. Nonetheless, maintaining a long-term loudness match does help lessen the audibility of the inevitable fades between reception modes, a necessary part the HD Radio 'hybrid mode' operation.

Enabling AGC

The JUSTIN 808 level-matching utility, called AGC, or Automatic Gain Control, is On as a factory default. The switch to turn it On and Off is under Setup / AES Audio Adjustments. Again, this level-equalizing option is available only when the JUSTIN 808 is installed in the HD1 Airchain mode.

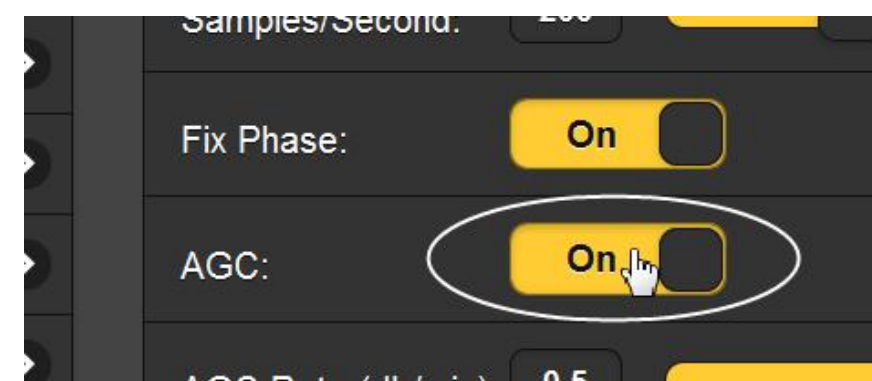

AGC Rate

The factory-default setting for the AGC Rate (dB/min) is 0.5 (0.5dB-per-minute correction), a good all-around figure. But this can be set anywhere between 0.1 and 1. Particularly when FM and HD1 are processed differently, a slower setting here will lessen any tendency for the JUSTIN 808 to 'hunt' for that 'perfect' level match, which would be impossible in practice.

Automatic Phase Correction

In addition to level-matching, the JUSTIN 808 is also capable of maintaining the absolute phase relationship between the FM and the HD1 programs.

This is not to say that the two programs will be phase-coherent at all frequencies; the fact that one program utilizes analog transmission with pre- and de-emphasis, and the other has an all-digital path, makes this improbable. Separate audio processing systems even further 'smear' the phase relationship between programs. But with all variables considered, the absolute phase between programs (normal vs. reversed) will be automatically optimized. This feature is operational as a factory default selection, and is available whether the JUSTIN 808 is in the FM or the HD1 airchain.

This Fix Phase: function may be turned On or Off under Setup / AES Audio Adjustments, and its status confirmed under FM/HD Measurements.

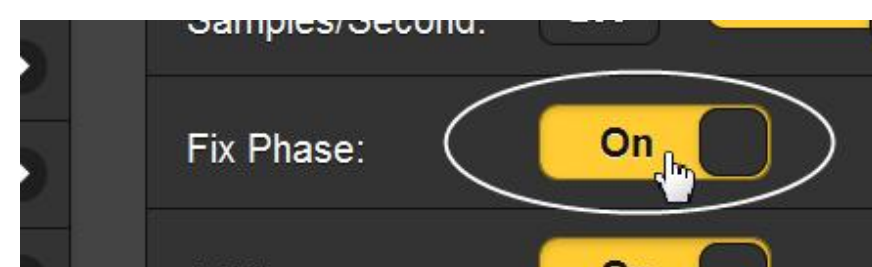

Level Correction History

A 'rolling' 10-minute Level History plot is displayed on the FM/HD Measurements menu screen. Here the HD Level, plotted in blue, is shown as a deviation from the FM program level, the long-term average of which is implied as the 0dB baseline. HD Gain, in red, graphs the slowly-applied correction to bring the HD level closer to 0dB.

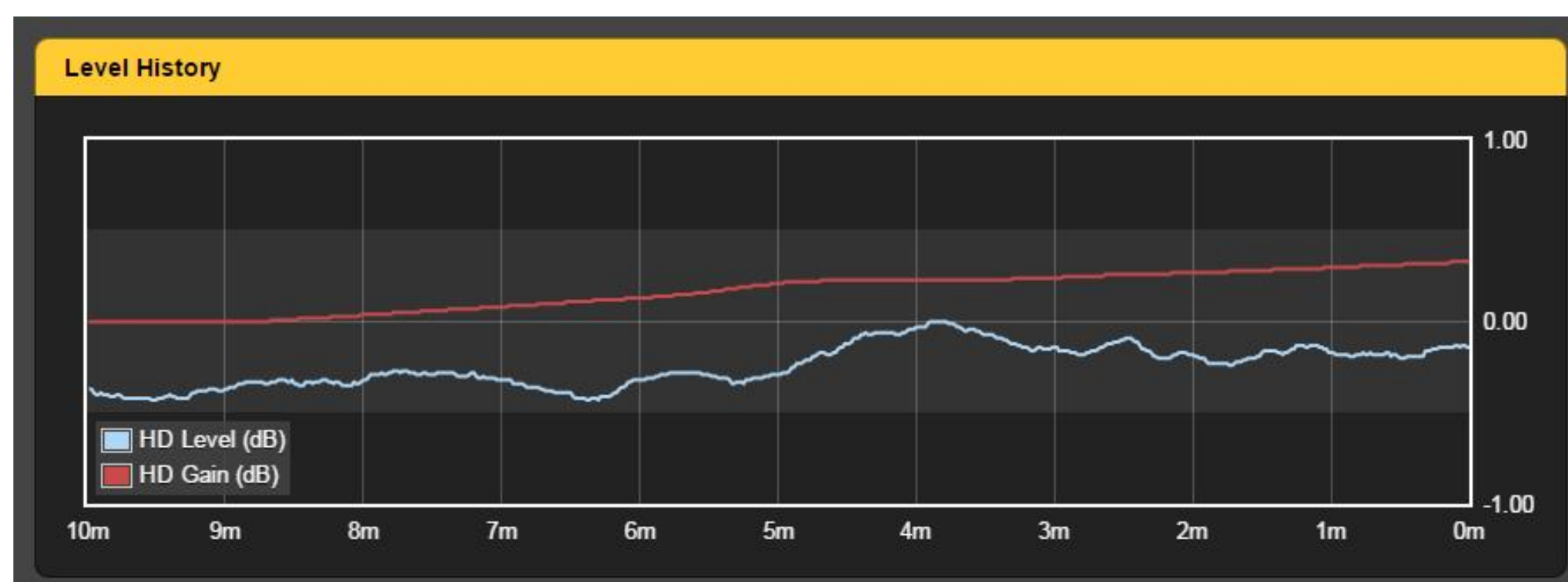

It should be possible to hold the HD level within ± 1 dB of the FM program channel. But especially with independent audio processing setups, that blue line is bound to wander a bit. The graph scale changes its range to keep the plots on the screen. The JUSTIN 808 data-logging utility does not keep an extended record of this level variance.

DATA LOGGING

The time-stamp feature for e-mail notifications, for data logging and for the alarm log, depends on Internet time, and with the proper time-zone offset entered. This procedure was detailed on Page 13, Step 6. Please make sure that the current local time is displayed by the JUSTIN 808.

Short-term time-alignment and program level logging have been introduced as “histories” of these two metrics. But a long-term log of delay errors is created as well, and is accessed only through the FM/HD Measurements menu of the Web interface.

Click the Data Logging bar to show the entire logging screen. The upper portion is reproduced below.

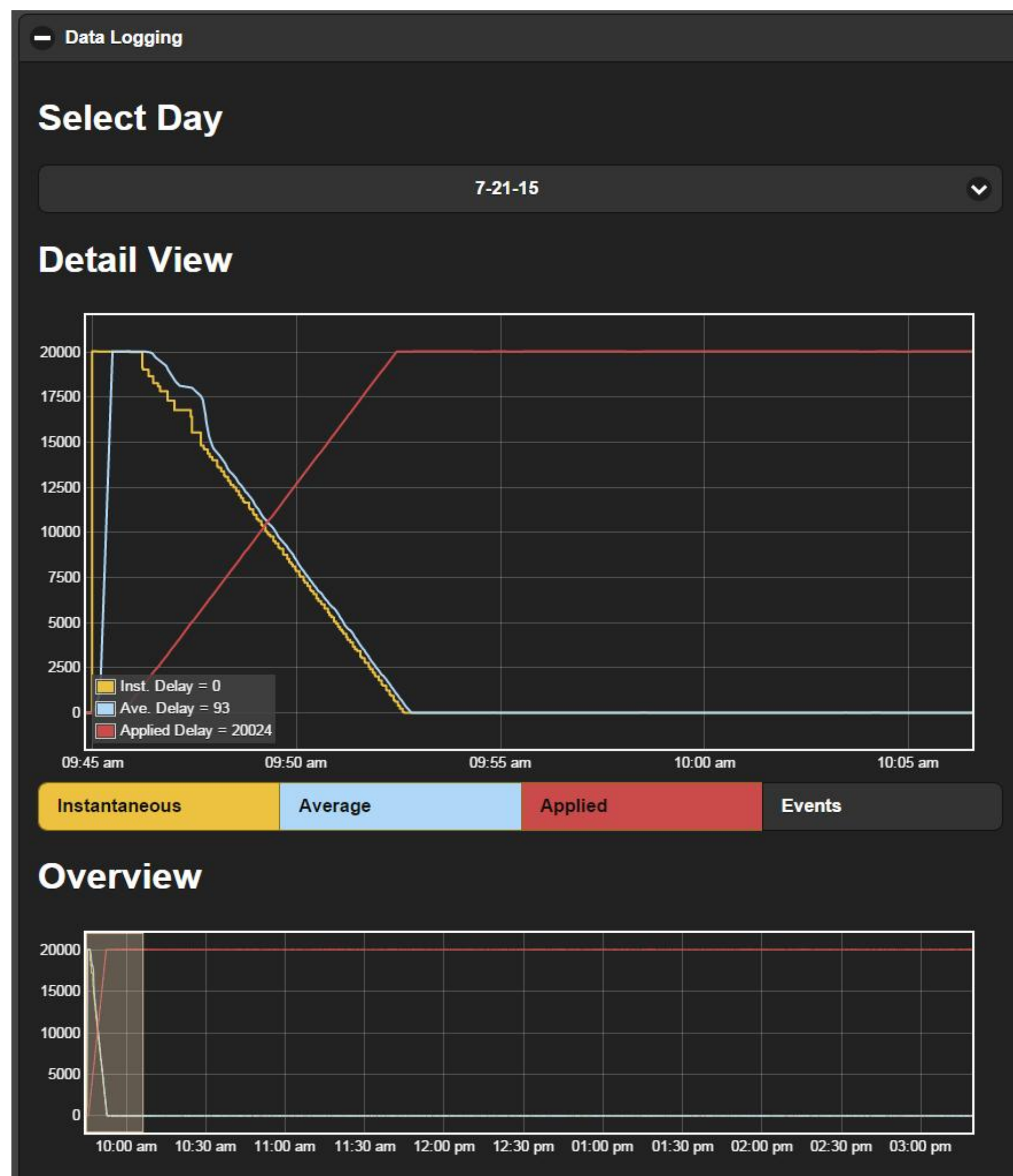

- The Overview Screen** Data logs are accumulated for each day, the day beginning at midnight or whenever the JUSTIN 808 is placed in service (9:30 in the example). The Overview screen keeps the start of the current day on the left and current time on the right. This screen will “shrink time” as the day advances. You can click on the Select Day bar for a pull-down listing of previous days to bring up their entire 24-hour logging period.
- Refreshing the Screen** The Overview screen graphs instantaneous and averaged time-alignment errors, plus the delay applied by the JUSTIN 808. This graph is not ‘real-time dynamic.’ In other words, the data shown are downloaded from the JUSTIN 808 when you click on Data Logging to open the screen. It does not continue to accumulate as you watch. To update the display, close and reopen the Data Logging view.
- Detail View** You may position your mouse pointer anywhere on the Overview screen, hold down the left mouse button, and ‘drag’ the cursor to highlight a specific logging time period. When you release the button the highlighted time will be transferred to the upper Detail View plot, as in the example.
- The four colored bars beneath Detail View are actually On/Off buttons for the displays of the named functions. These all are ‘On’ as a factory default, but you can turn any or all of them off. For example, turn the Events plot off if its descriptive text for noted events clutters the graph so that a trend in the delay alignment cannot be seen easily.
- You can zoom-in on the Detail View plot by dragging your cursor in that display in the same manner as for the Overview plot. If you happen to expand a section in which the data had no change at all, the screen will black-out. Close and reopen Data Logging to restore the plot or ‘swipe’ another section of the Overview graph.
- Statistics** This field displays the minimum, maximum, range and average values of measured delay errors, as well as for the applied delay. Figures are given both in the number of samples and in milliseconds of time. Statistics are for the current day’s data between midnight and the present, or for the entire 24-hour logging period of any previous day.
- Events** An ‘Event’ is not necessarily an alarm condition. Rather, the term refers to changes in operation of the JUSTIN 808. For example, when the JUSTIN 808 loses and finds correlation, this will be noted. Also when the unit is tuned to a different frequency, regains AC mains power, or whenever the Ballgame Mode is selected, and by what means. Click View Events for an itemized listing of all events in the current logging period, or for any previous day’s 24-hour log.
- The Events listing may be ‘filtered.’ Type a parameter of interest into the Filter event types... field. In this example, the term

ballgame mode was typed into the box, bringing up all instances of this mode change.

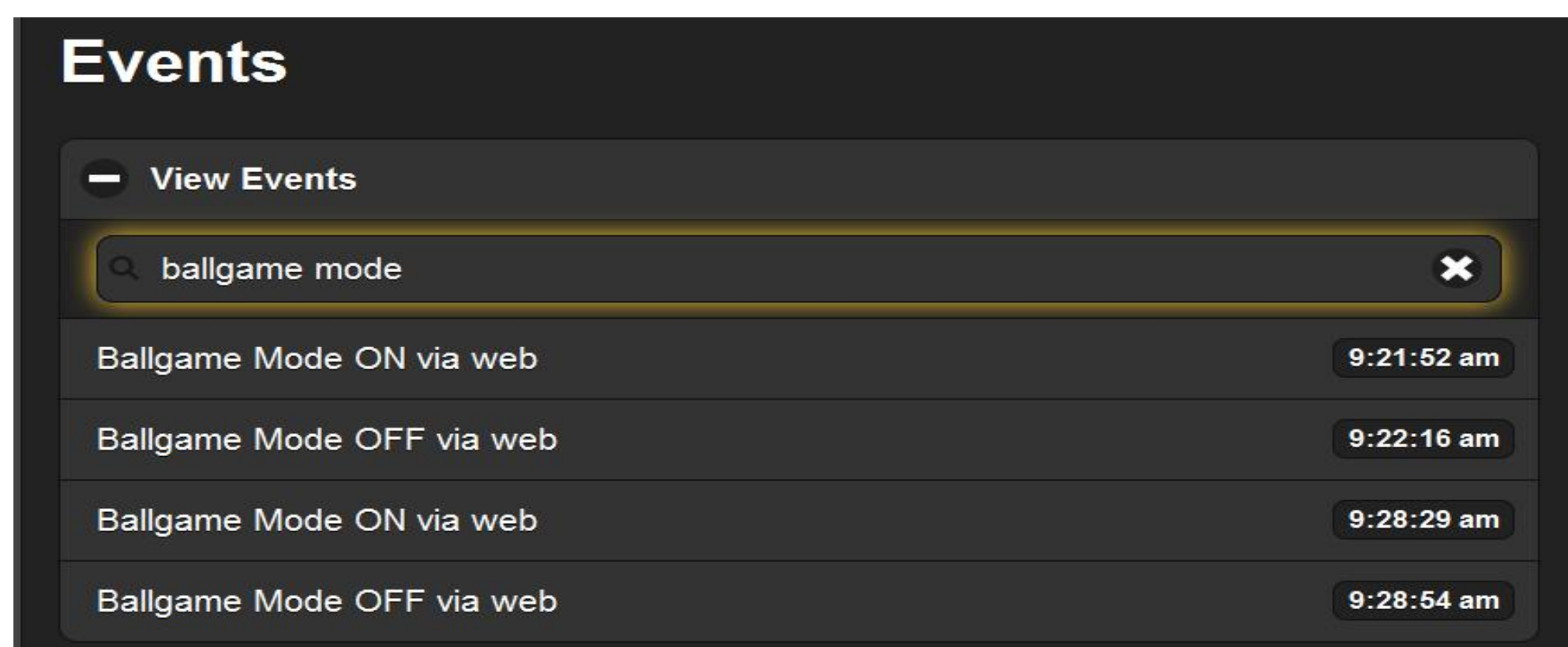

Click the **X** to the right of this field to restore all events.

Saving the Log

The logs just discussed are automatically saved indefinitely in JUSTIN 808 hardware memory, precluding any need to purge this log. There is, of course, a finite memory limit, but this will be decades in normal operation.

Individual days' logs may be saved as a comma-separated values (csv) text file on your computer. For the current day (up to the present time), or for any day specified in Select Day at the top of the window, just click Download (date) and follow any prompts that your computer gives you.

TIME SPENT

This utility gathers information concerning what portion of the JUSTIN 808's total operating time is spent performing the necessary functions. This is displayed as a form of "pie chart" with a color-coded key identifying each function.

The utility may be Reset manually at any time to begin a new survey.

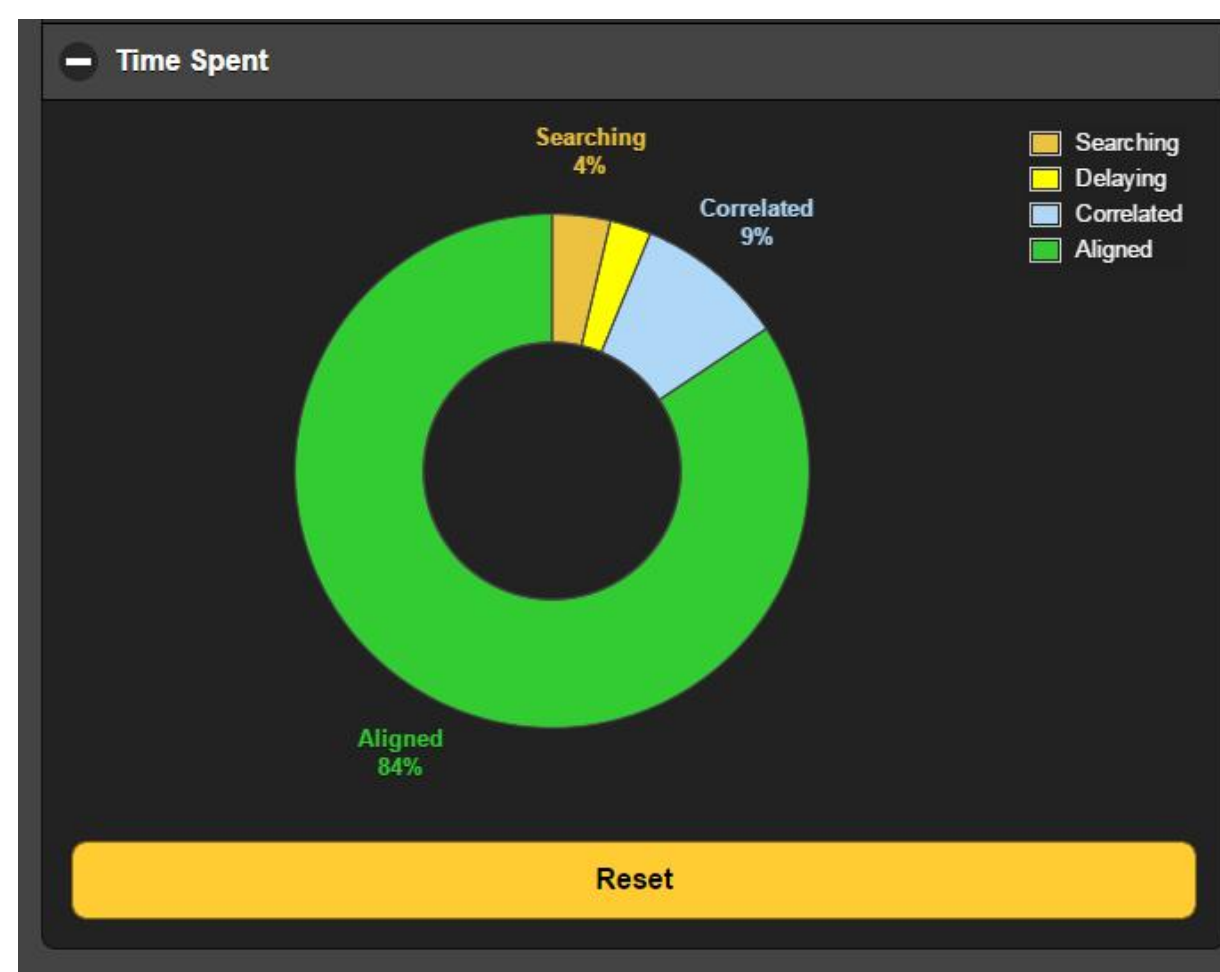

ALARMS AND NOTIFICATIONS

A valuable feature of The JUSTIN 808 is the alarm utility, which apprises the user of these possible fault situations:

1. Loss of FM Audio
2. Loss of HD1 Audio
3. Loss of AES (loop-through) Audio
4. FM carrier loss (or a drop in level)
5. HD Radio Carrier Loss
6. Alignment Out of Range

These alarms are indicated on the front panel of the JUSTIN 808, either as individual LED indicators, or they are flashed on the OLED display. These alarms are also assignable as rear-panel ‘tallies.’ Also, any alarm may be independently programmed to send e-mail or text messages to selected station personnel.

False Alarm Guards

Each of the six alarms has independent trigger and reset thresholds, allowing almost any degree of hysteresis to be applied to any setting, whether it’s a signal level or any other quantity. Each alarm has independent trigger and reset time intervals as well. These two features guard against false alarms and help ensure legitimate ones.



Enable Alarms!

Keep in mind that these alarms are *not enabled* as a factory default, and even the front-panel indicators will not signal a fault condition until that alarm has been ‘turned on,’ either through the front panel menus or the Web interface.

The alarms will be discussed in the order that they appear, which is common to both the front-panel menu tree and the Web interface under Alarms and Notifications from the Main Menu

FM Audio Loss

This alarm signals “dead air,” not to be confused with the station’s being “off-air.” The typical and characteristic ‘inter-station hiss’ will generally keep this alarm from triggering when the carrier disappears. The exception to this involves a Mute: (squelch) feature presented under the Low Signal alarm discussion.

FM Audio Loss

Alarm: On

Threshold On (dB): -30

Threshold Off (dB): -20

Time On (s): 30

Time Off (s): 15

Using the Web interface, as shown above, click the top Alarm: button to toggle this alarm between On and Off. From the front-panel OLED menu, check or uncheck the Alarm box.

In this example, once the received peak program level drops 30dB below 100% modulation, and stays below -30dB for 30 seconds, an FM Audio Loss alarm will be triggered. The alarm will reset once the program returns, and remains above -20dB, for 15 seconds.

HD Audio Loss The HD Audio Loss alarm is identical to the FM Audio Loss example just discussed, and a similar setup routine applies. The only difference is that a loss of the HD Radio digital carrier pair will not result in the ‘inter-station hiss’ condition typical of analog FM. Thus loss of the HD carrier will always trigger this audio-loss alarm as well.

AES Audio Loss This alarm monitors the AES digital audio that is looped-through the JUSTIN 808. Setup of this alarm is identical to the other two audio-loss alarms. Loss of the looped-through audio will always result in one of the other audio loss alarms being triggered, as the looped audio is being delayed and transmitted, either as the HD1 program or the FM channel.

Flashing Alarms Any front-panel AUDIO LOSS alarm LED will flash during the Time On (s): interval, and then glow steadily until the alarm resets.

Audio-Loss Alarm Considerations The three audio-loss alarms are peak-responding to program material, but with a slow ‘fallback.’ They will register even the briefest program peak, but that peak will take approximately a full second for the measured value to drop 20dB.

This has implication with respect to setting the thresholds and alarm on/off times. Most contemporary radio programming will maintain program peaks close to 100% modulation almost continuously. One exception is classical music, which may have extended *pianissimo* passages, though even these will probably have frequent *peak* values in excess of the -30dB in our example above. Another format is ‘spoken word,’ which runs the gamut from poetry readings to newscasts. This program material will have more of a staccato nature with frequent pauses.

In both cases, the threshold levels are probably not as important as the Time On (s): and Time Off (s): settings. In general, a longer Time On (s): will prevent extended pauses or low-level passages from triggering an alarm, and a longer Time Off (s): will give greater assurance that the situation has returned to normal. Remember, shorter settings may dispatch an annoying succession of alarms.

Low Signal The Low Signal alarm is keyed to RSSI:, the Received Signal Strength Indicator. This alarm may be programmed to alert staff to a drop in power, to an unexpected receive-path issue, or to a total transmitter failure. This alarm is similarly enabled or disabled by clicking on the Web interface Alarm: button or

front-panel OLED menu Alarm checkbox.

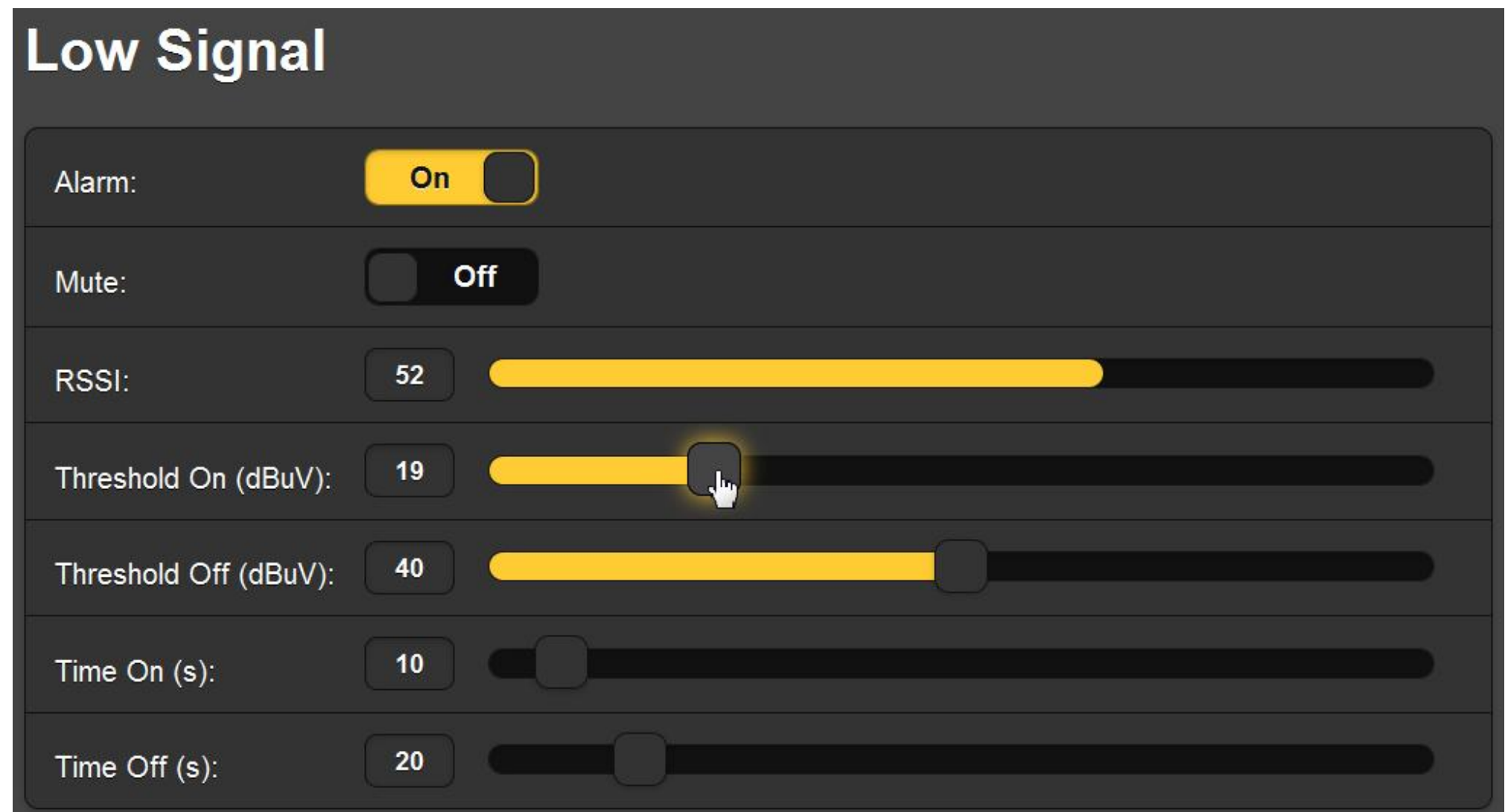

The RSSI: readout displays incoming carrier strength. The numerical value represents the level in dB μ V, or dB relative to one microvolt measured at the antenna input.

Threshold On (dBuV): is the level that the RSSI: must fall to, and remain below for the Time On (s): interval, to trigger an alarm. The returning carrier must reach the Threshold Off (dBuV): and remain above this level for the Time Off (s): period to reset the alarm.

When setting these alarm parameters, it's a good idea to note the RSSI: reading over a day's operation so that you can factor-in any normal signal fading as a result of atmospheric effects.

The Mute Function

As already mentioned, an FM receiver will generally output a high level of FM inter-station hiss when no carrier is received. This would prevent an FM Audio Loss alarm in the event of a total transmitter failure.

The JUSTIN 808 incorporates a mute function that automatically squelches the off-air FM audio for a Low Signal condition. This feature is turned On or Off with the Web interface Mute: button or with the Mute checkbox on the front-panel OLED menu. Turning Mute: On will assure that both the Low Signal and FM Audio Loss alarms will be triggered should the transmitter fail. Otherwise the FM Audio Loss alarm will respond only to 'dead air,' and the Low Signal alarm, alone, will signal a transmitter failure.



HD Carrier Loss

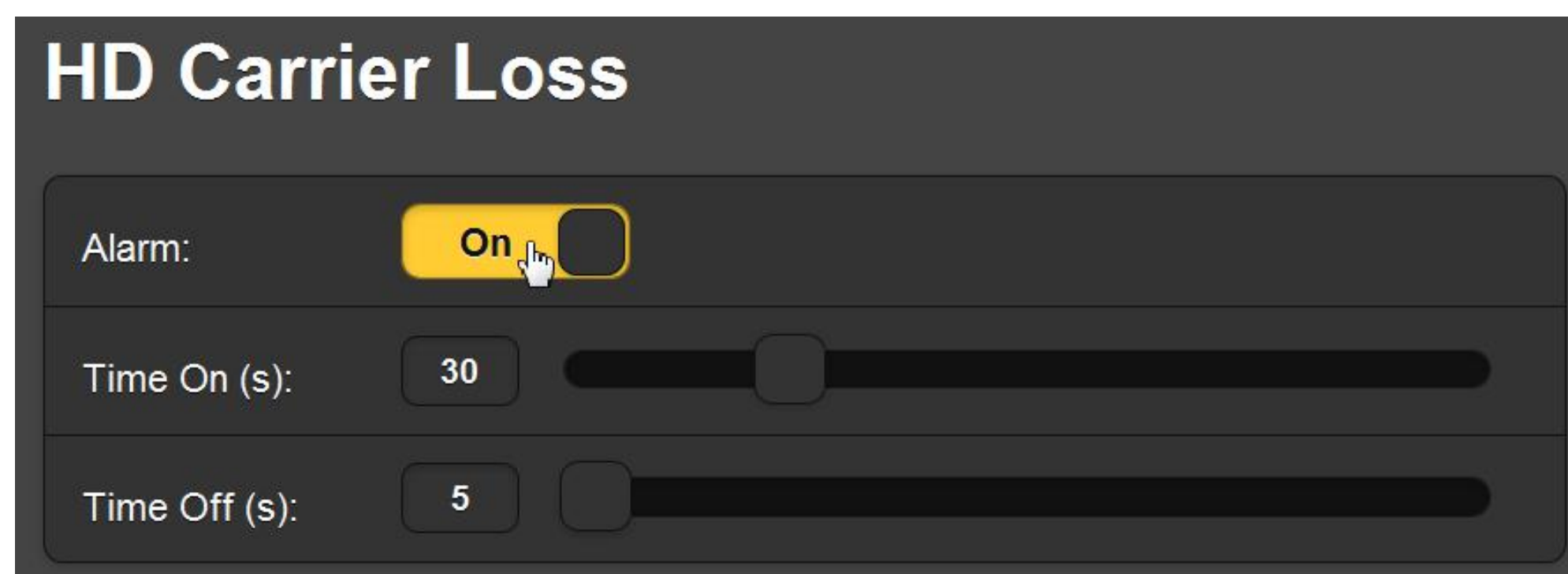

The HD Carrier Loss alarm is turned On or Off with the Web interface Alarm: button, as shown here, or with the Alarm checkbox on the front-panel OLED menu. This alarm responds to the presence or absence of the HD1 digital ‘carrier’. There are no threshold settings, only Time On (s): for the alarm to activate once the HD1 signal is lost, and Time Off (s): for the alarm to reset when HD1 is reacquired.

The HD Radio digital signal is actually quite robust, despite its power subservience to the analog FM carrier. Yet it retains the characteristic of any digital ‘go’ or ‘no-go’ situation. ‘Hits’ on this alarm may be correlated with the HD bargraph on the front-panel OLED Tuner menu, or with the Digital Quality numerical readout on the Web interface Now Playing screen.

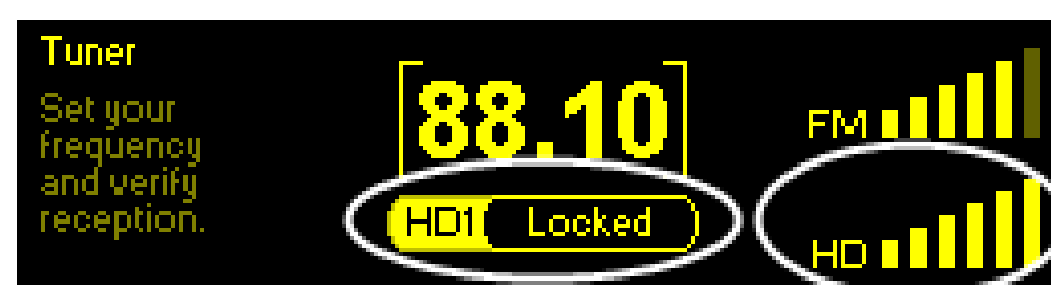

Digital Quality	HD1
100%	Locked

Alignment Out of Range

This alarm triggers when FM-to-HD1 alignment exceeds a preset number of Threshold On (smp) samples for a preset Time On (s): interval.

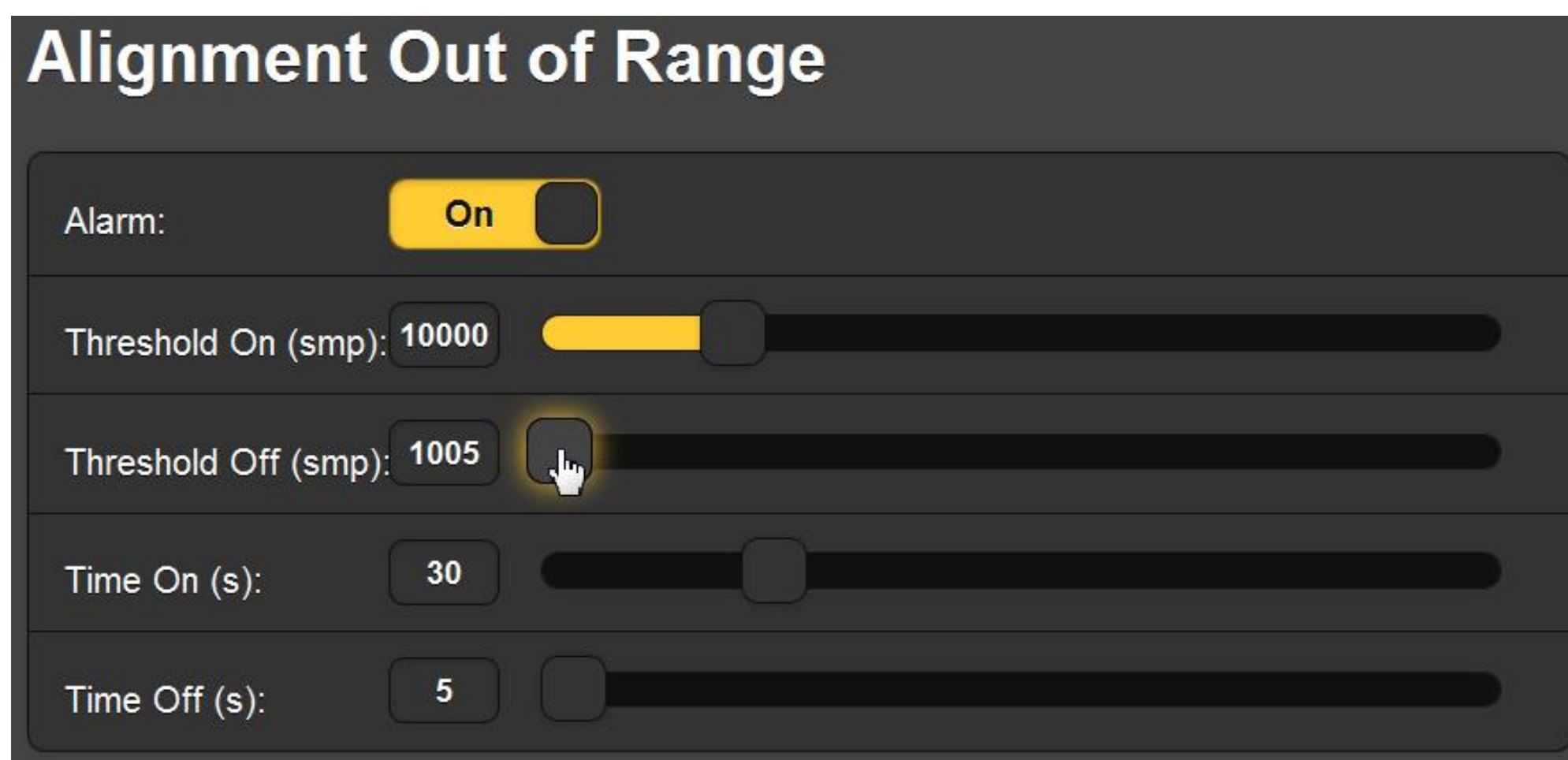

Any ‘glitch’ in the HD exciter/exporter operation that causes time alignment to slip will, of course, prompt the JUSTIN 808 to re-correlate and begin readjusting the delay to bring the FM and

HD1 programs back into sync. But this could take some time, perhaps more than the 2-minute limit of the programmable Time On (s): interval.

You can prevent alarms for infrequent self-correcting instances by setting the Threshold On (smp): to a higher number of samples. (10000 samples equate to a quarter of a second of time misalignment). This number can be set much lower in systems that prove themselves stable over time.

Keep in mind that delay offsets are automatically logged and archived, and these can be analyzed for specific events or for trends at your leisure.

ALARM TALLIES

The alarms just discussed are available as ‘tallies’ at the rear-panel GPIO (General Purpose In/Out) port terminal block. The GPOs (outputs) are simply identified 1 through 5, and must be assigned their function and logic polarity through the Setup / General Purpose Output menu, using either the Web interface or in a very similar manner from the front-panel OLED menu screen.

Polarity GPOs are open-circuit in one condition and an NPN transistor saturation to ground in the other. This means that these outputs are looking for an external positive voltage. A current-limited +5V terminal is included on the block, although any voltage up to +30VDC may be applied.

Click in the Polarity: callout area to switch output logic between the two choices. Active Ground means that an alarm condition will apply a ground to the output terminal; Active Open means that the terminal is normally grounded and will go open for an alarm.

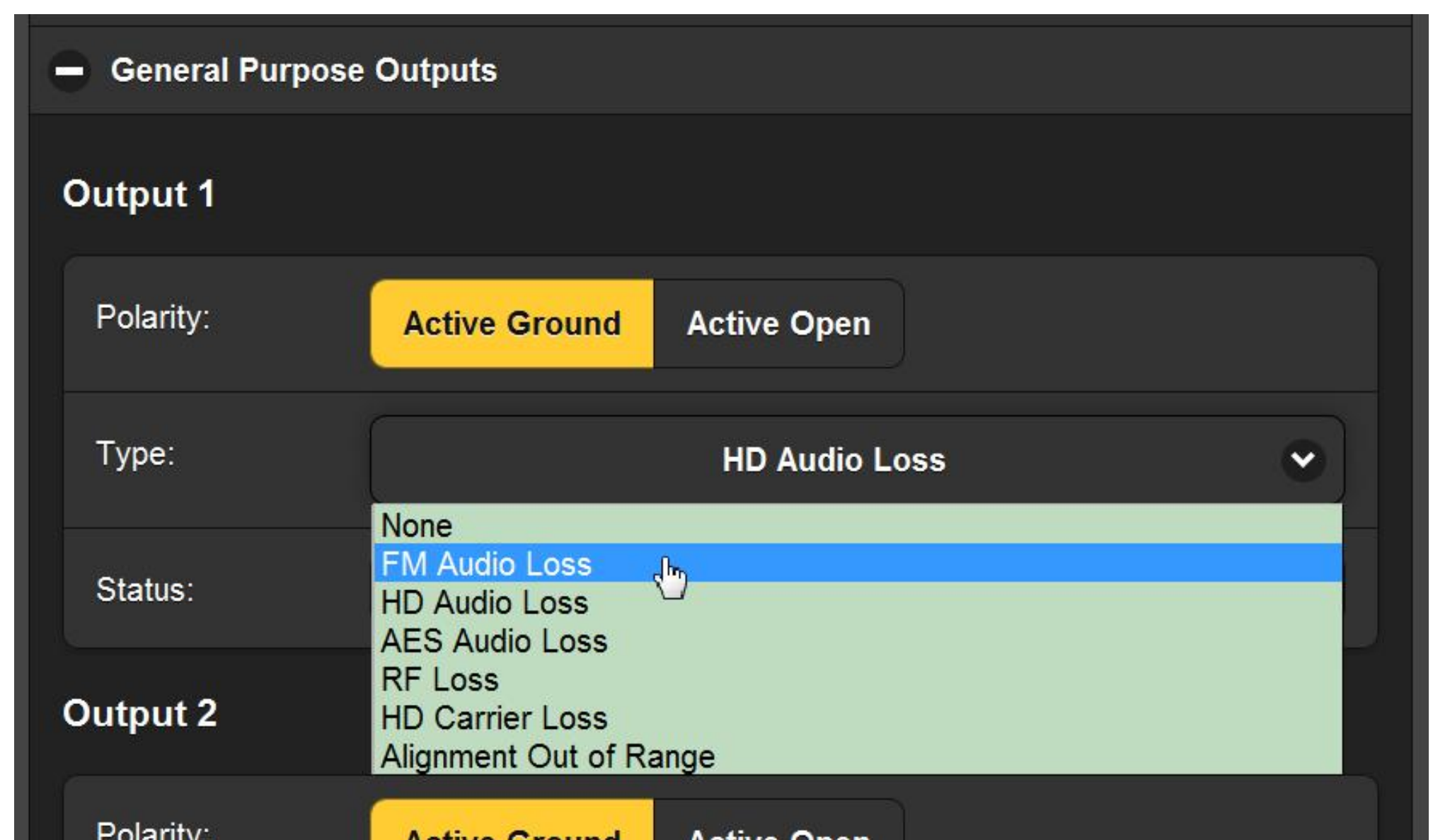

- Type** Click in the area to the right of Type: for a pull-down menu of assignment options. When one of these is clicked, it becomes the alarm assigned to that output. In the example above, Output 1 is now the FM Audio Loss alarm.
- Status** This area shows the current status of the assigned alarm, whether it is Active or Inactive (triggered or not) at that precise moment. Remember that each alarm must be enabled before the tally will respond (see Page 27).

EMAIL AND SMS/TEXT NOTIFICATIONS

Any JUSTIN 808 alarm can be programmed to dispatch an SMS/text or email message when the alarm is triggered. Multiple recipients may each 'subscribe' to any or to all alarms.

Setting-Up SMTP The JUSTIN 808 becomes as an email 'client' (program) when sending alarm notifications, and must be set-up properly first in that regard.

This is done most easily using the Web interface through Email Preferences off the Main menu. Front-panel setup is very similar, and Email Preferences is found under Setup off the Main menu there.

The following illustration shows server setup for an example installation.

SMTP Server:	smtp.gmail.com
Port:	465
SSL:	<input checked="" type="checkbox"/> On
From:	JUSTIN@KINO
User:	kinojustin@gmail.com
Password:	••••••••
Recipient 1:	CE@kinoradio.com
Recipient 2:	

For this example, a separate Gmail account was set up for the JUSTIN 808 at KINO Radio. The SMTP Server: and Port: infor-

mation are default for Google's Gmail per the Gmail Website account setup guide.

The From: field is a 'friendly' name for the sender, something that recipients will recognize in their inboxes. User: is the formal username for this Gmail account; this one happened to be available when the account was set up; anything will do.

The email address of the Chief Engineer for the station was typed into the Recipient 1: box, other recipients for alarms would be entered into the remaining boxes, up to a total of ten.

After all data have been entered, click Save at the bottom of the screen. You may then click Send test Email, and all re-



cipients will receive one of these in short order. Here's the example Inbox notification with the actual message appended.

Search for a message		
From	To	Subject
JUSTIN@KINO	CE@kinoradio.com	Test email - 88.10

This is a test email to verify that SMTP is working.
Details of the unit this email originated from:
Frequency: 88.10 MHz
IP Address: 192.168.0.151
Hostname: JUSTIN808
The alarm log is 11% full.

Texting to Mobile Devices

SMS/text messaging; that is, sending alarms directly to a cell phone number, is done in the same manner. The cellular carrier can supply instructions for addressing text messages from email accounts to a 10-digit mobile phone number on their system.

Assigning Alarms

Assigning certain alarms to specific email or SMS/text recipients is accomplished under Alarms & Notifications / Email Notifications: from the Web interface or the front-panel OLED menu. An example is shown at the top of the next page.

Click the checkmark at the far right of the Recipient: field for a pull-down list of all email addresses that have been entered as described above. Click on an address, and with the selected recipient showing in the box, simply check all alarms to be sent to that specific email or SMS/text address. This task may also be accomplished from the front panel in much the same way.

Email Notifications

Recipient: 1. CE@kinoradio.com ▼

Send Emails For:

- FM Audio Loss
- HD Audio Loss
- AES Audio Loss
- RF Loss
- HD Carrier Loss
- Alignment Out of Range
- Daily Alarm/Data Log
- Weekly Alarm Log
- Monthly Alarm Log

ALARM LOG SETTINGS

The Alarm Logs Settings area at the bottom of this screen is reproduced on the following page. It shows the Status: of the alarm log capacity, and the slider below that allows the log to generate its own alarm, Email when % full:. There is also provision to Download Alarm Log as a .csv text file, which can be read with Microsoft Excel or other spreadsheet program, and a button to Clear Alarm Log. Keep in mind that clearing the log will sabotage any daily, weekly or monthly automatic downloads that have been programmed for email/SMS-text recipients.

Clicking the + Alarm Log bar will bring up an on-screen listing of all alarms logged since the log was last cleared. Just as with Data Logging, these Alarm Log data are downloaded from the JUSTIN 808 when the Alarms & Notifications menu is opened. Alarms do not show up immediately in the list; the page must be refreshed to see the most recent happenings.

Alarm Log Settings

Status: 15% full

Email when % full: 50

Clear Alarm Log Download Alarm Log

— Alarm Log

Alarm	Station	Time	Date
HD Carrier Back	88.10	10:12:46 AM	7/13/15
HD Carrier Loss	88.10	10:11:13 AM	7/13/15
HD Carrier Back	88.10	10:10:41 AM	7/13/15

GENERAL PURPOSE INPUTS & OUTPUTS

General Purpose Inputs (GPI)

The rear-panel GPIO (General Purpose In/Out) port terminal block carries five GPI (input) terminals, labeled 1 through 5. These must be assigned a function and logic polarity through the Setup / General Purpose Output menu, using either the Web interface or, in a similar manner, from the front-panel OLED menu screen.

— General Purpose Inputs

Input 1

Polarity: Active Ground Active Open

Type: Ballgame Mode

Status: None
Ballgame Mode
AES Passthrough

Polarity GPIs are pulled-up to an internal +5V rail. Click the Polarity: assignment area to toggle between Active Ground and Active Open. When Polarity: is set for Active Ground, a ground applied to the associated rear-panel terminal will enable the selected function. An Active Open must normally be held to ground, and then opened to select the function.

Type Two functions are programmable with closures or opens to ground: Ballgame Mode and AES Pass-Through. The former enables the Ballgame Mode (discussed next) and the latter activates

a bypass relay in the AES digital audio loop-through path, essentially removing the JUSTIN 808 from the airchain completely. Future functions may be assigned to spare GPIs.

Status The **Status:** area will indicate whether that input is Active or Inactive at that instant.

General Purpose Outputs (GPO) GPOs are for exclusive use as alarm ‘tallies’ and are covered on Page 31.

BALLGAME MODE

Given the obligatory 8+ seconds of delay required for the HD Radio system to encode, transmit and decode the digital audio program, an all-digital play-by-play ballgame broadcast would not go over well with those listening in the stands. But at least the corresponding delay necessarily introduced in the analog FM broadcast channel can be returned to ‘real time.’ There are a number of options associated with this function, which is a separate Ballgame Mode submenu under Setup.

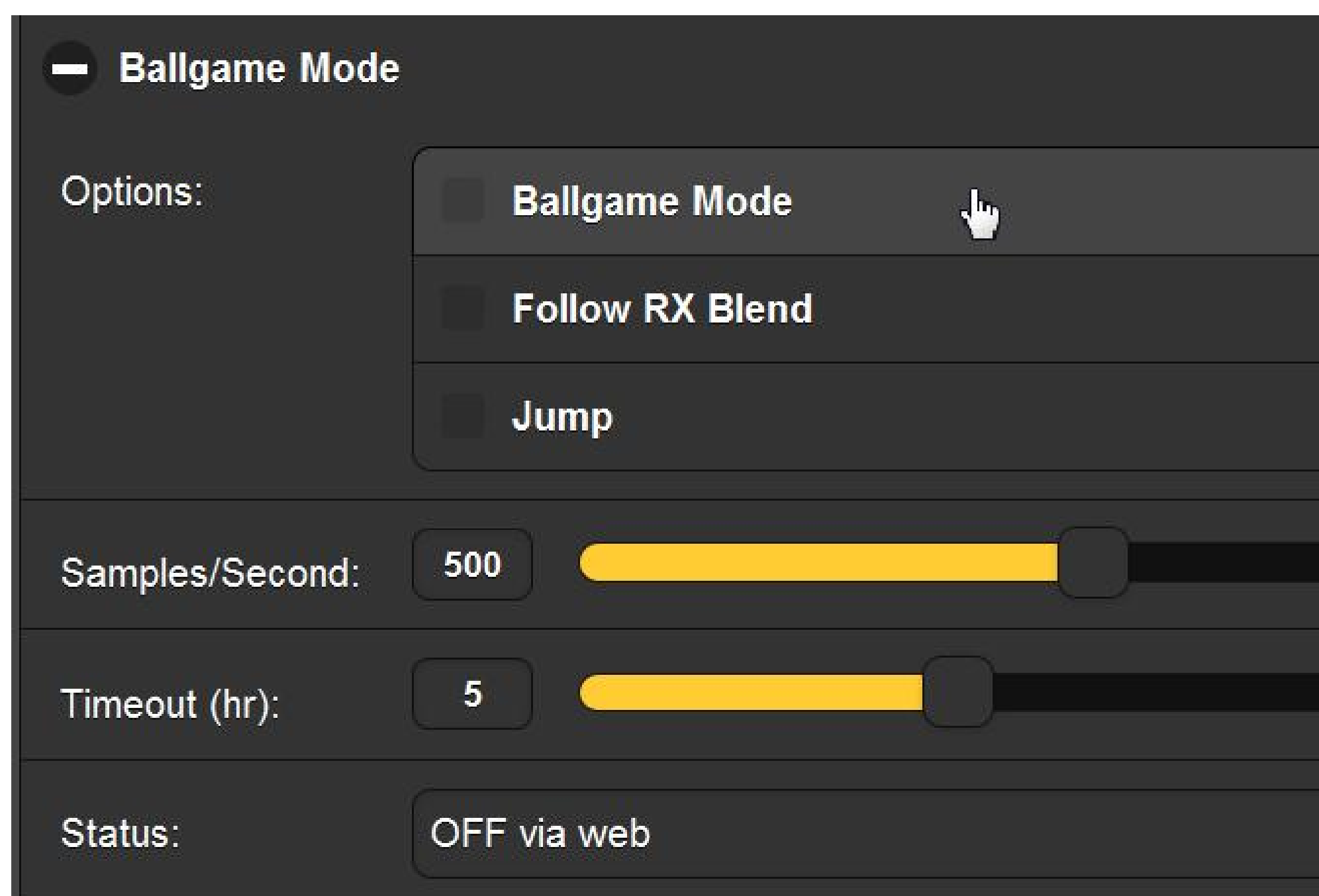

The Ballgame Mode may be activated by one of four means:

1. Manually from the front panel, under **Setup / Ballgame Mode / BG Mode On/Off**.
2. Manually via the Web interface, by clicking **Ballgame Mode** on the screen shown above.
3. Automatically, if the HD Radio installation includes the requisite metadata with the HD1channel. In that case, simply check **Follow RX Blend**. When the system issues a command for receivers NOT to blend from analog to digital (as

for a ball game), the JUSTIN 808 will put itself in the Ballgame Mode.

4. With a contact closure (or open) on the rear-panel GPIO terminal (see Page 35).

When entering and leaving the Ballgame Mode, the JUSTIN 808 will gradually change the delay time at the rate programmed into the Samples/Second: box. This can be a faster rate than the usual correction rate, as it will occur only when the Ballgame Mode is turned on or off.

An alternative is jumping instantly to a zero-delay figure by checking Jump. This is similar to the ‘instant jump’ feature described next.

INSTANT JUMP

As previously explained, the actual correction for a time-alignment error can be quite lengthy, especially given constraints imposed by Nielsen PPM performance. A “jump” provision has been included that allows an instant delay correction to occur *immediately* after the JUSTIN 808 has correlated the delay offset.

Instant Jump is found under Setup and offers a manual means of affecting this instantaneous delay offset correction.

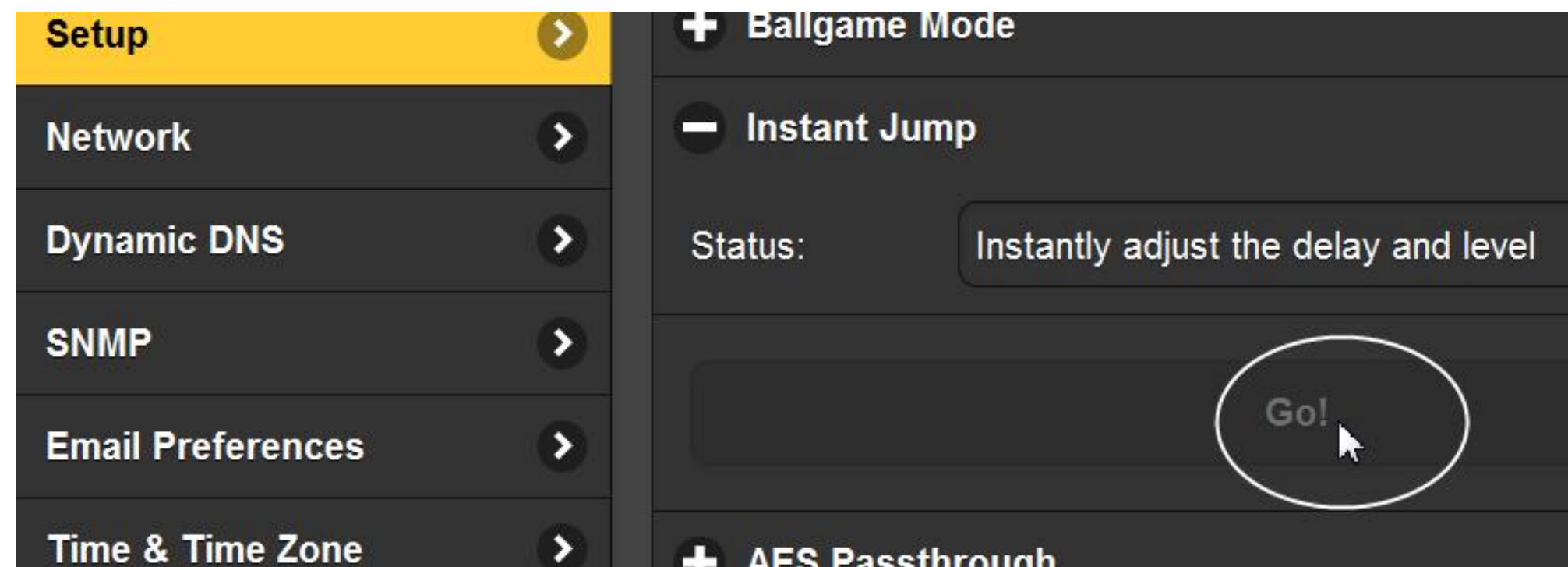

As long as Status: indicates that correlation has been acquired, you can click Go! to instantly correct any measured delay offset. Remember, this will be audible.

From the front panel, navigate to Setup / Instant Jump, and then activate the Go! button.

AES PASS-THROUGH

A metallic-contact relay-bypass is provided for the AES digital audio signal looped through the JUSTIN 808. First and foremost, this ensures that no programming is interrupted as the result of a power failure.

Under the Setup menu, AES Pass-Through ‘radio buttons’ offer a manual means of dropping these relays out as well. Engage AES Pass-Through to bypass the AES audio, otherwise it should be left in factory-default Normal Operation as shown.

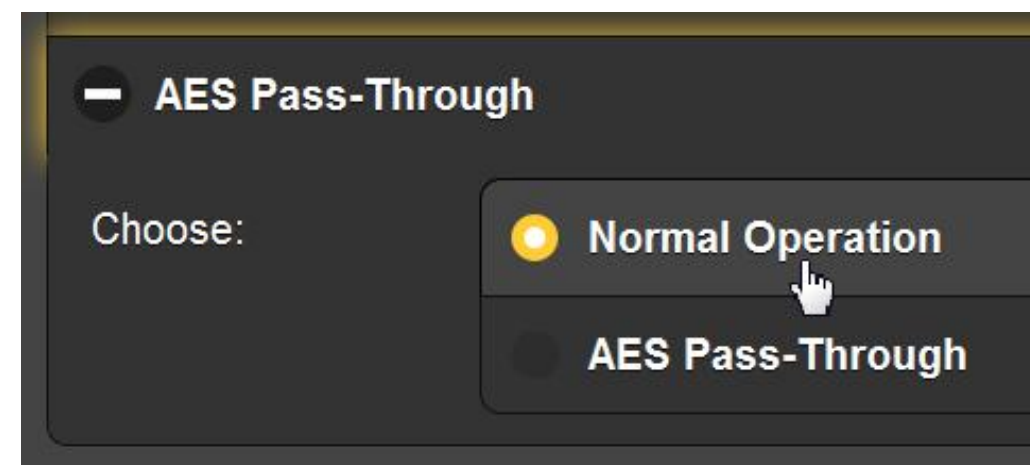

A similar set of radio buttons can be found under **Setup / AES Pass-Through** on the front-panel menu tree.

SNMP OPERATION

SNMP Overview SNMP, or Simple Network Management Protocol, allows other TCP/UDP/IP equipment on the same Local Area Network (LAN) to communicate directly with the JUSTIN 808, and for the JUSTIN 808, itself, to initiate an alarm on the network.

The JUSTIN 808 will interface directly with a network controller, which technically is known as the SNMP ‘Manager.’

SNMP Mode Open the SNMP menu page. Under SNMP Settings the factory-default setting for Mode: is Disabled. This inhibits communication between the JUSTIN 808 and the SNMP Manager.

Changing Mode: to Read Only allows the JUSTIN 808 to be interrogated by the SNMP Manager so that the various alarms can be integrated with other equipment on the network.

Setting the Mode: to Read & Write allows the SNMP Manager to send commands to the JUSTIN 808, essentially putting the JUSTIN 808 under total remote control by other station equipment.

SNMP Security SNMP ‘Communities’ serve as passwords for this function. Go into the Read: and Write: boxes to enter text that is specified for the read/write strings on the SNMP Manager monitoring device. Execute a Save after entering this text.

SNMP Ports General Port 161 and Trap Port 162, are default SNMP ports and customary assignments for a majority of SNMP operations. These may be changed as required.

SNMP Traps When the JUSTIN 808 *initiates* an alarm, rather than being *queried* or *polled* for one, the alarm is known as a ‘trap.’ Three local network IP addresses may be entered into the three Trap Destination: boxes, each IP address corresponding to other devices on the LAN that want to be notified of alarms.

Be sure to initiate a Save command after any SNMP entry is changed.

The MIB File The JUSTIN 808 incorporates an embedded ASCII text file called a Management Information Base, or MIB. In setting up for SNMP operation, the MIB file will have to be downloaded from the JUSTIN 808 and uploaded to the SNMP Manager. Click **Download MIB** to initiate the process; the file is saved in the usual Windows manner. The MIB file is in plain text and may be read with Windows Notepad.

SNMP setup can be done from the front panel of the JUSTIN 808 as well, although the Web interface is easier and faster. Find the front-panel setup under **Setup / Network / SNMP**.

The foregoing discussion of SNMP operation is purposely abbreviated. SNMP is a complex utility, managed exclusively by whatever SNMP Manager (the monitoring equipment) is employed. Refer to all instructions specific to the SNMP Manager when setting-up the JUSTIN 808.

ADMINISTRATIVE SETTINGS

On the Admin menu page, the upper Security area allows the direct entry of passwords to protect three areas of JUSTIN 808 operation. These may be entered from the front panel as well.

Front Panel Password

Entering a Front Panel: password here will inhibit any navigation of the OLED menus until the password is entered on the JUSTIN 808 front panel using the Back button and knob. A default display of measured and applied delay time will be the only local viewing option. Push the front-panel Back button and the display will change to **Locked** and then show the password-entry screen.

Use the knob to select alphabets, numbers and punctuation marks to enter the password. Then highlight **Done** and press the knob

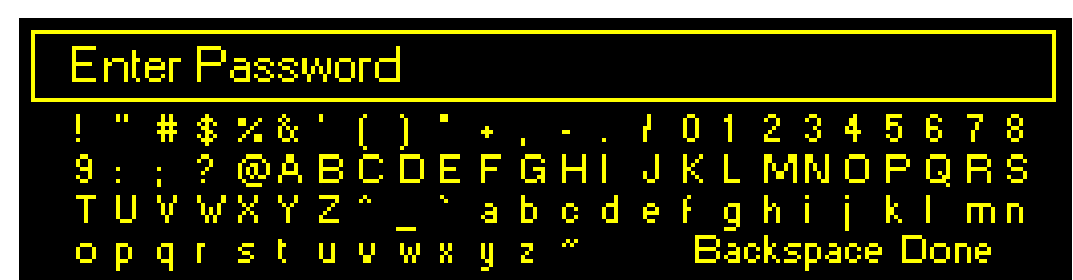

once more. The front panel will become fully accessible until the OLED timeout period has expired, which will then require the password to be entered again.

For extended operation from the front-panel, you can navigate to **Admin / Display** and set **Timeout** to a temporary period of the maximum, 60 minutes. You may also remove the password by navigating to **Admin / Security**. The password will be visible, so write it down so that you can re-enter it to restore front-panel security. Use **Backspace** to remove the password and then select **Save**.

With the front-panel password enabled, the JUSTIN 808 OLED display will lock any time the panel controls are left untouched for the programmed timeout period. It may also be locked immediately by holding down the Back button for a few seconds.

Web Interface Password

The JUSTIN 808 Web interface may be password-protected as well. Enter a password into the Webpages: area and click Save Passwords.

From this point forward, anytime a Web browser attempts to access the JUSTIN 808 a pop-up window similar to the one shown here will appear on your screen. Appearance of the password entry box will depend on the browser.

You may neglect the User name: field, only the Password: needs to be entered. Your browser may give you the option of its remembering the password, which is your choice.



Ballgame Mode Password

The JUSTIN 808 Ballgame Mode, discussed on Page 36, may be independently password-protected; just type the password into the Ballgame field.

This allows a person to be responsible for turning the Ballgame Mode on and off, but denies access to other JUSTIN 808 setup parameters. That person would type the IP address of the JUSTIN 808 into a browser followed by: /ballgame.htm. For example: 192.168.0.122/ballgame.htm.

Lost Password (Hard Reset)

To recover control of the JUSTIN 808, if the password is lost, you must do a “hard reset” of the unit. This is accomplished by holding down the Back button as you power-cycle (disconnect and then reconnect AC-mains power).



A hard reset deletes not only passwords, but will also return the JUSTIN 808 to all-factory-default values. *All user settings will be lost!* This is a good example of why it’s important to maintain an up-to-date Hardware Profile.

Hardware Profile

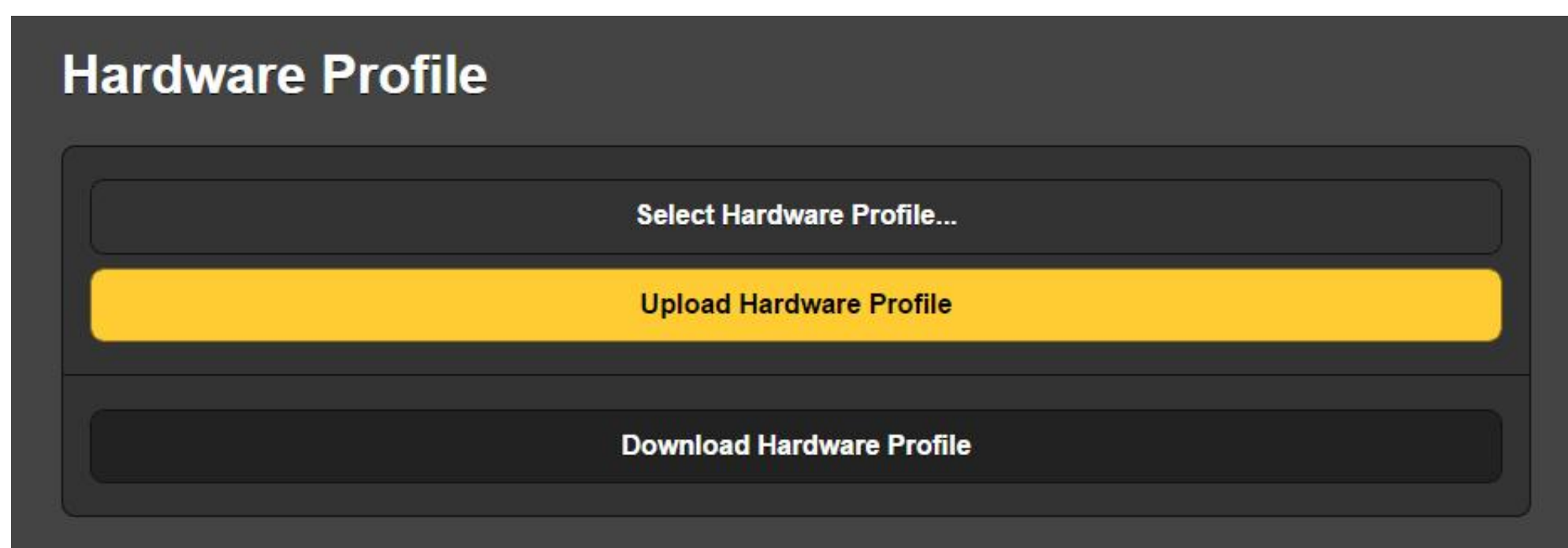

A Hardware Profile is a small .ini file that contains all setup parameters of the JUSTIN 808. This may be downloaded to your

computer simply by clicking Download Hardware Profile. The file may be read with MS Notepad or any text editor.

The hardware profile is useful for setting-up a replacement JUSTIN 808 instantly, so that options and choices do not need to be entered all over again. Keeping this file up-to-date guards against losing this information in the event that a hard reset becomes necessary, or if lightning or some other force of nature makes a replacement mandatory.

Click Browse to find the Hardware Profile on your computer, and then click Upload Hardware Profile to restore all your setup options to another JUSTIN 808.

Firmware Update

JUSTIN 808 firmware and Web interface pages are easily uploaded to the unit when updates are issued by Inovonics.

First, however, it's a good idea to update your Hardware Profile before doing a Firmware Update, as the process may affect some user settings.

Updates are issued as small .bin files which may be downloaded to your computer Desktop or placed in any convenient folder. From the Firmware Update utility at the bottom of the Admin screen, click Select Firmware File... and then navigate to the downloaded file and double-click it. This will transfer the file, updater as shown here.

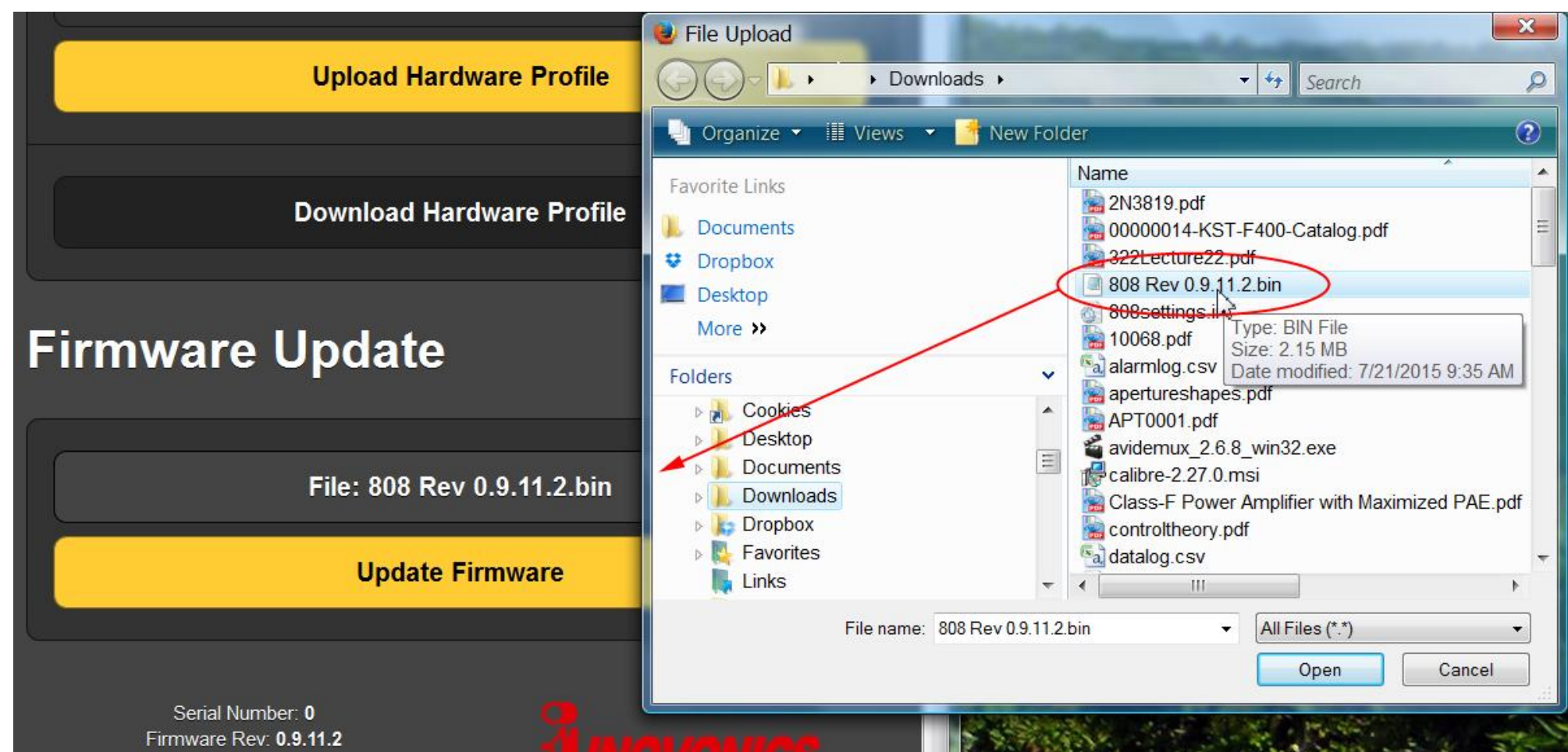

Click Update Firmware and follow prompts to complete the process. Updating takes a couple of minutes and will return you to the Web interface pages once the operation is complete.

Headphone Volume

The front-panel OLED menu tree lists a separate submenu titled Headphone Volume. This rarely needs to be brought-up manually because it pops up by itself whenever a pair of headphones is plugged into the front panel jack. Use the knob to adjust listening level to a comfortable point.

About

The bottom of the Admin menu page will give information on the serial number, version of firmware and 'Uptime' for your JUSTIN 808. Uptime is the total number of days and hours that the unit has been in operation since it was first installed, or

since the last Hard Reset.

In addition, clicking Check for Updates will take you to the Inovonics Website and any information regarding new options available for your unit.

Section IV

APPENDIX

THE FRONT-PANEL MENU TREE

The several levels of menus for setup and operation of the JUSTIN 808 are laid out in an intuitive and easy-to-manage fashion. A complete listing of the front-panel OLED menus is tabulated on the following pages.

Menu Titles are shown in a font that approximates that of the front-panel display. Main Menu items are against the left margin, submenu levels are indented appropriately. A contrasting font defines the descriptive callout in parentheses following menu items.

Each menu level indicates whether that level is simply a (display) of an operating parameter, or whether it accepts some form of user entry. (set) generally signifies an on/off or enable/disable function, (select) denotes user control over a much wider range of choices, perhaps selecting between a number of options or adjusting some value in very small increments. (enter) calls for alphanumeric character entry into data fields.

Tuner

[XXX.XX] (main tuning selector)
HD1 (HD signal capture status display)
FM (signal strength bargraph display)
HD (digital signal quality bargraph display)

FM/HD Measurements

FM/HD Radio Time
Measured Delay
Samples (display of delay offset in number of samples)
Time (display of delay offset in milliseconds)
Applied Delay
Samples (display of delay correction in number of samples)
Time (display of delay correction in milliseconds)
Status (display of current operation)
FM/HD Radio Level
HD Level (measured dB level difference)
HD Gain (dB level correction applied to HD1)
Phase (Normal or auto-Reversed)
Measured Delay History (running graphic display showing 60 seconds' worth of delay offset in instantaneous and average values)

Applied Delay History (running graphic display showing 60 seconds' worth of delay applied by JUSTIN 808)

Level History (running graphic display showing 60 seconds of measured HD1 level offset and gain correction applied by JUSTIN 808)

AES Audio Adjustments

AES Audio Time
Enable Delay (enable or disable)
Jump on boot (enable or disable)
Samples per second (adjust delay correction rate in samples/sec)

AES Audio Level

Fix Phase (enable or disable automatic phase correction)
Enable AGC (enable or disable auto level correction [with JUSTIN 808 in HD1 audio path only])
Correction Rate (adjust AGC correction rate in dB/min)

AES Airchain (select signal path)

Analog FM (⊙ unit in FM signal path)
Digital HD1 (⊙ unit in HD1 signal path)

Alarms and Notifications

FM Audio Loss

- Alarm (enable or disable)
- Threshold On (set alarm trip threshold in dB)
- Time On (set alarm trip delay in seconds)
- Threshold OFF (set alarm reset threshold in dB)
- Time Off (set alarm reset delay in seconds)

HD Audio Loss

- Alarm (enable or disable)
- Threshold On (set alarm trip threshold in dB)
- Time On (set alarm trip delay in seconds)
- Threshold OFF (set alarm reset threshold in dB)
- Time Off (set alarm reset delay in seconds)

AES Audio Loss

- Alarm (enable or disable)
- Threshold On (set alarm trip threshold in dB)
- Time On (set alarm trip delay in seconds)
- Threshold OFF (set alarm reset threshold in dB)
- Time Off (set alarm reset delay in seconds)

Low Signal

- Mute (enable or disable audio mute for low-signal condition)
- Alarm (enable or disable)
- Threshold On (set alarm trip threshold in dB)
- Time On (set alarm trip delay in seconds)
- Threshold OFF (set alarm reset threshold in dB)
- Time Off (set alarm reset delay in seconds)

HD Carrier Loss

- Alarm (enable or disable)
- Time On (set alarm trip delay in seconds)
- Time Off (set alarm reset delay in seconds)

Alignment Out of Range

- Alarm (enable or disable)
- Threshold On (set alarm trip threshold in samples of error)
- Time On (set alarm trip delay in seconds)
- Threshold OFF (set alarm reset threshold in samples of error)
- Time Off (set alarm reset delay in seconds)

Email Notifications (select email recipient and specify alarms and logs sent to that recipient)

Alarm Log

- Alarm (displays type)
- Station (displays frequency)
- Time & Date (displays time and date of alarm)

Setup

Network

IP Settings

- Static IP (or) DHCP (select)
- Port: (set)
- IP: X.X.X.X (enter static IP address)

Gateway: X.X.X.X (enter static IP gateway)

Subnet: X.X.X.X (set static IP subnet)

DNS: X.X.X.X (set static IP DNS server)

Hostname (enter a name for your JUSTIN 808)

Dynamic DNS

Mode: (disable or select a DNS provider)

Host: (enter assigned DNS host name)

User: (enter assigned DNS user name)

Pass: (enter selected DNS password)

Time

Time Zone & DST

DST (disable or enable fulltime fulltime DST)

Auto DST (disable or enable automatic DST adjustment)

Time Zone (select offset from UTC, ±12 hours in half-hour increments; also displays current date & time)

Time Server

Server: (accept default US Government server or enter alternate URL)

SNMP

Mode & Communities

Mode (select Disabled or Read Only or Read & Write)

Communities

Read: (enter community-read string)

Write: (enter community-write string)

SNMP Ports

General Port: (enter port number)

Trap Port: (enter port number)

Trap Destinations

IP1: X.X.X.X (enter IP address)

IP2: X.X.X.X (enter IP address)

IP3: X.X.X.X (enter IP address)

Status

MAC: X.X.X.X.X.X (displays the fixed MAC address of your JUSTIN 808)

Internal IP: X.X.X.X (displays the current IP address of your JUSTIN 808)

External IP: X.X.X.X (displays your IP address as assigned by your ISP)

DynDNS: X.X.X.X (displays Disabled or your dynamic IP address, if used)

Router: (displays connection status of your JUSTIN 808 to router or server)

Email Preferences

SMTP Server

SMTP Server (enter server info)

Use SSL (enable or disable SSL)

Port: XXX (accept default Port 25 or enter an alternative SMTP port number)

Sender (enter account info)
From: (enter 'From' text)
User: (enter username)
Pass: (enter password)
Recipients
Select: (define a recipient by a number between 1. and 10.)
Address (enter the email address of the numbered recipient)
Send Test Email (send an instantaneous test email to all registered recipients)
Alarm Log Settings
Status: (displays how full the alarm log is)
Email When: (select a 'percent-full' for sending an alert to designated recipients)
Clear Log (select and execute to purge the alarm log completely)
General Purpose Inputs
Input: (select an input [1 to 5] for programming)
Polarity:
Active Ground (the input is activated when a normally-open terminal is grounded)
Active Open (the input is activated when a normally-grounded terminal goes open)
Type: (select a function to be controlled by the selected input)
(Also indicates whether input is active or not at the present moment)
General Purpose Outputs
Output: (select an output [1 to 5] for programming)
Polarity:
Active Ground (the output is pulled to ground when activated)
Active Open (the output is normally grounded and goes open when activated)
Type: (select any of five alarm conditions for the selected output)
(Also indicates whether the output is active or not at the present moment)
Ballgame Mode
BG Mode On/Off
Ballgame Mode (enable or disable)
Timeout (set a hard reset of this mode [disable] after 1 to 6 hours)
Follow RX Blend (enable or disable the Ballgame Mode to follow a command embedded in HD Radio metadata)
Status (displays current status of Ballgame Mode and source of command)

BG Mode Ramp Options
Jump (enable or disable immediate jump to zero applied delay)
Ramp (samples/second) (select the rate at which the delay will ramp into, or out of, the Ballgame Mode if Jump is not enabled)
Instant Jump
Delay (displays the current actual delay offset in samples)
Level (displays the current actual level offset in dB)
Go! (activate this to instantly bring the Applied Delay value to the Measured Delay figure)
AES Pass-Through
 Normal Operation (or) AES Pass-Through (select for relay-bypass of looped-through AES audio)
De-Emphasis
 50us (or) 75us (select for region)
Admin
Security
Front Panel: (enter a password that will have to be re-entered to access front-panel OLED screens)
Webpages: (enter a password to restrict access to the Web interface)
Ballgame: (enter a password to restrict access to Ballgame Mode programming)
Display
Brightness: (adjust the brightness of the front-panel OLED display)
Dim: (after the programmed Timeout period, dim the display or turn the display off)
Timeout: (program the display to dim or to turn off after 5 to 60 minutes)
About
Firmware Rev: (the version of firmware installed in your JUSTIN 808)
Ethernet: (shows Connected or Disconnected)
Serial #: (the serial number of your JUSTIN 808)
Uptime: (total days, hours and minutes that your JUSTIN 808 has been in operation since its initial installation)
Headphone Volume
Volume (adjust the audio level at the front-panel headphone jack)



INOVONICS WARRANTY

- I TERMS OF SALE:** Inovonics products are sold with an understanding of “full satisfaction”; that is, full credit or refund will be issued for products sold as new if returned to the point of purchase within 30 days following their receipt, provided that they are returned complete and in an “as received” condition.
- II CONDITIONS OF WARRANTY:** The following terms apply unless amended *in writing* by Inovonics, Inc.
- A. The Warranty Registration Card supplied with this product *must* be registered online at www.inovonicsbroadcast.com, within 10 days of delivery.
 - B. This Warranty applies only to products sold “as new.” It is extended only to the original end-user and may not be transferred or assigned without prior written approval by Inovonics.
 - C. This Warranty does not apply to damage caused by misuse, abuse, accident or neglect. This Warranty is voided by unauthorized attempts at repair or modification, or if the serial identification label has been removed or altered.
- III TERMS OF WARRANTY:** Inovonics, Inc. products are warranted to be free from defects in materials and workmanship.
- A. Any discrepancies noted within THREE YEARS of the date of delivery will be repaired free of charge, or will be replaced with a new or remanufactured product at Inovonics’ option.
 - B. Parts and labor for factory repair required after the three-year Warranty period will be billed at prevailing prices and rates.
- IV RETURNING GOODS FOR FACTORY REPAIR:**
- A. Equipment will not be accepted for Warranty or other repair without a Return Authorization (RA) number issued by Inovonics prior to its return. An RA number may be obtained by calling the factory. The number should be prominently marked on the outside of the shipping carton.
 - B. Equipment must be shipped prepaid to Inovonics. Shipping charges will be reimbursed for valid Warranty claims. Damage sustained as a result of improper packing for return to the factory is not covered under terms of the Warranty and may occasion additional charges.